

# Unique pools

Hotel & Spa | 2024

by  ROSA  
GRES



**04**

Proyectos  
Projects  
Projets

**78**

Servicios  
Services  
Services

**82**

Seguridad  
Security  
Sécurité

**84**

Nuevo pavimento drenante  
New draining pavement  
Nouvelle chaussée drainante

**90**

Colores  
Colors  
Couleurs

**98**

Sistemas constructivos, piezas especiales  
Construction systems, trim pieces  
Systèmes de construction, pièces spéciales

**116**

Cocina industrial  
Industrial kitchen  
Cuisine industrielle

**120**

Sostenibilidad  
Sustainability  
Durabilité

**123**

Características técnicas  
Technical characteristics  
Caractéristiques techniques

Dar la vuelta al mundo con nuestro gres porcelánico es uno de los retos más motivadores que existen. Los colores Rosa Gres han viajado a hoteles de todos los continentes.

El secreto es soñarlo y trabajar inspirados para estar ahí. Con un equipo increíble preparado para crear proyectos únicos. Acompañando a cada cliente con verdadera ilusión y el espíritu de partner que nos identifica como empresa.

En este catálogo descubriréis una selección de nuestros proyectos de Hotel más emblemáticos. Os mostramos nuestras soluciones constructivas, colores y texturas. Todas pensadas para crear detalles únicos, confort y la máxima seguridad para vuestros huéspedes.

Deseamos inspirarte y te invitamos a confiar en nuestro equipo. La calidad, la resistencia, la funcionalidad, la creatividad y la sostenibilidad son los valores que guían la creación de todos nuestros productos y soluciones.

En Rosa Gres ecodiseñamos todos nuestros productos y sistemas constructivos para reducir su impacto ambiental.

Nos encantará compartir contigo lo que hemos aprendido a lo largo de más de 50 años explorando nuevos proyectos en todo el mundo. Porque sabemos, como tú, que cada Hotel es una experiencia única, un Hotel único.

Gracias por estar aquí.

Traveling around the world with our porcelain stoneware is one of the most motivating challenges of all. The Rosa Gres colors have traveled to hotels on every continent.

The secret is to dream and to work with the inspiration that comes from being there. With an incredible team willing to create unique projects. Guiding each client with true enthusiasm and the spirit of partnership that distinguishes us as a company.

In this catalog, you will discover a selection of our most emblematic hotel projects. We present our constructive solutions, colors and textures. All designed to create unique features, comfort and maximum safety for your guests.

We want to inspire you and invite you to place your trust in our team. Quality, durability, functionality, creativity and sustainability are the values that guide the creation of each and every one of our products and solutions.

At Rosa Gres we ecodesign all our products and construction systems in a way that reduces their environmental impact.

We cannot wait to share with you the things we have learned over the course of 50 years of exploring new projects all over the world. Because, like you, we know that every Hotel is a unique experience, a unique Hotel.

Thank you for being here.

Parcourir le monde avec notre grès cérame est l'un des défis les plus motivants qui soit. Les couleurs de Rosa Gres ont voyagé dans les hôtels de tous les continents.

Le secret est d'en rêver et de travailler avec inspiration pour y arriver. Avec une équipe incroyable prête à créer des projets uniques. Accompagner chaque client avec un véritable enthousiasme et l'esprit de partenariat qui nous identifie en tant qu'entreprise.

Dans ce catalogue, vous découvrirez une sélection de nos projets hôteliers les plus emblématiques. Nous vous présentons nos solutions de construction, nos couleurs et nos textures. Tous ces éléments sont conçus pour créer des détails uniques, un confort et une sécurité maximale pour vos hôtes.

Nous voulons vous inspirer et vous inviter à faire confiance à notre équipe. Qualité, solidité, fonctionnalité, créativité et durabilité sont les valeurs qui guident la création de tous nos produits et solutions.

Chez Rosa Gres, tous nos produits et systèmes de construction sont éco-conçus afin de réduire leur impact sur l'environnement.

Nous sommes heureux de partager avec vous ce que nous avons appris au cours de plus de 50 ans d'exploration de nouveaux projets dans le monde entier. Parce que nous savons, comme vous, que chaque hôtel est une expérience unique, un hôtel unique.

Nous vous remercions d'être là.























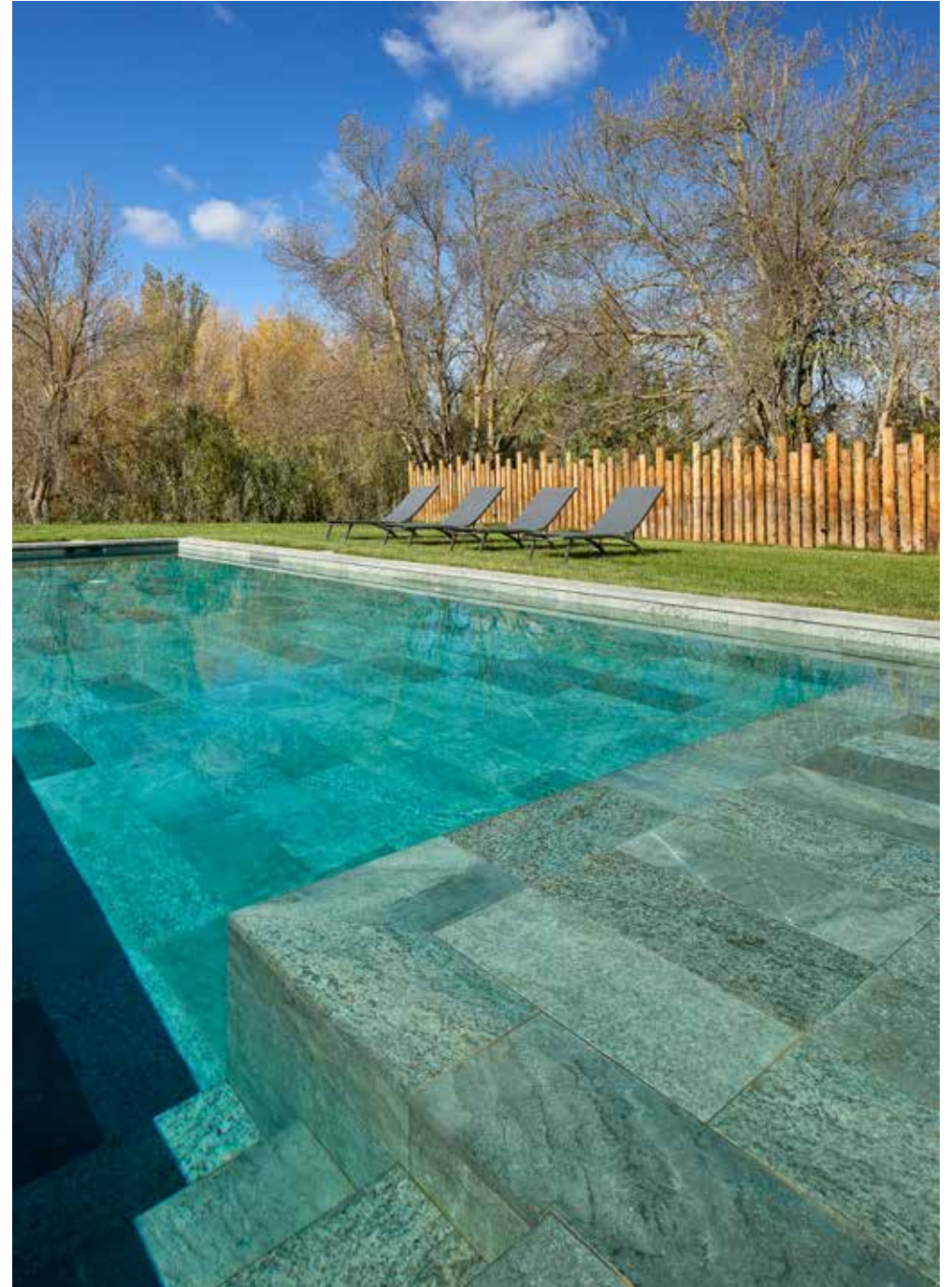





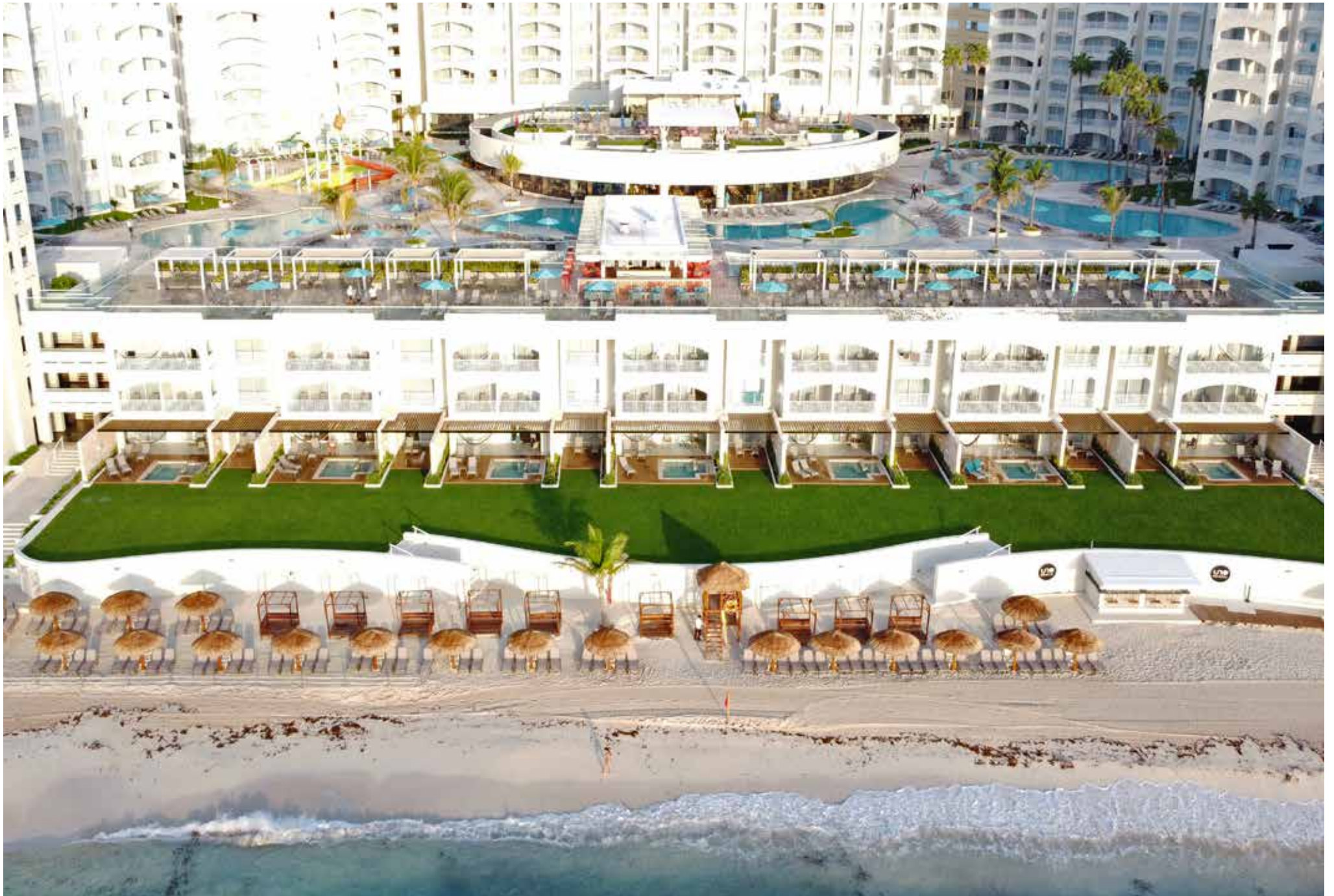



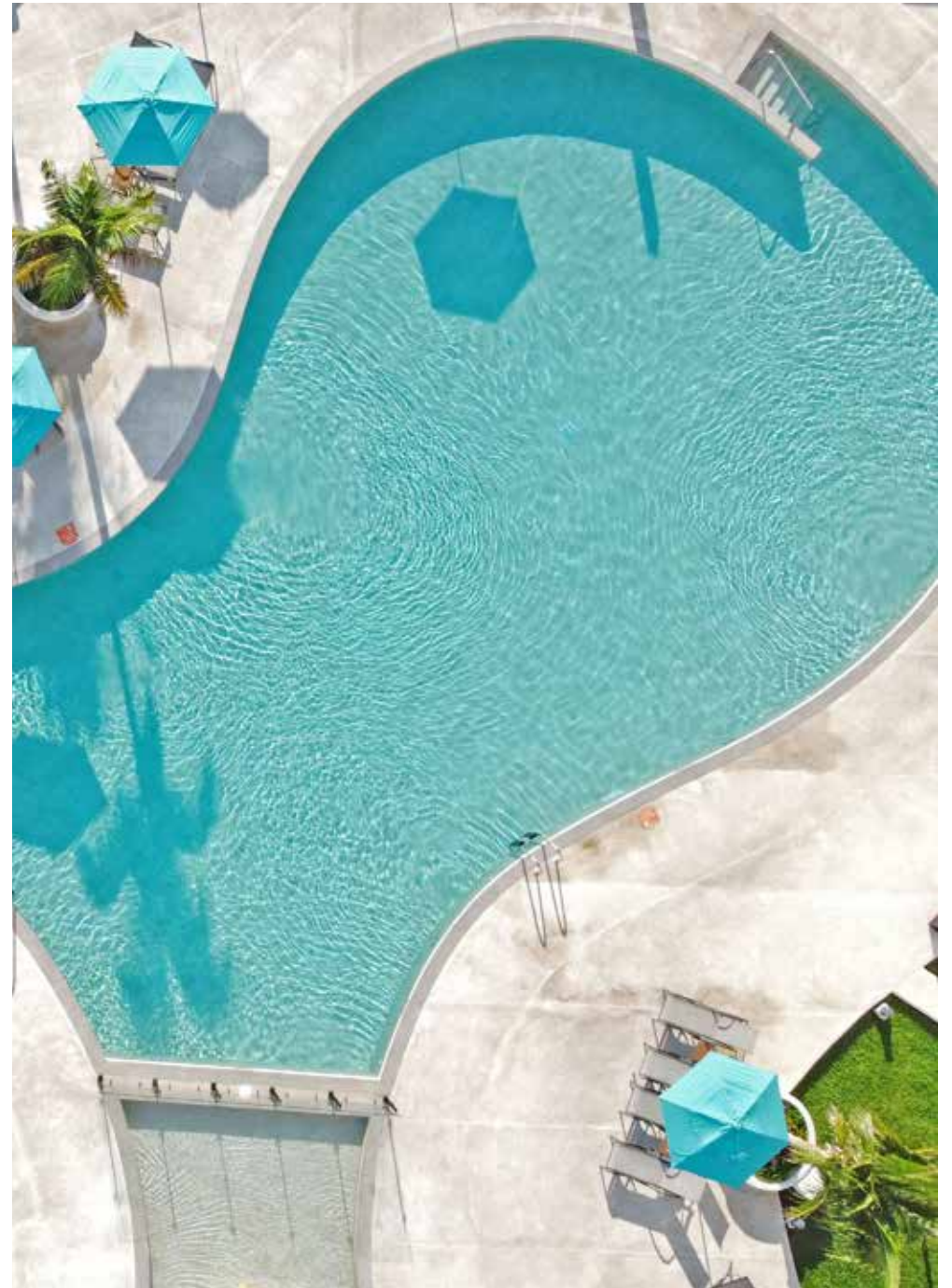







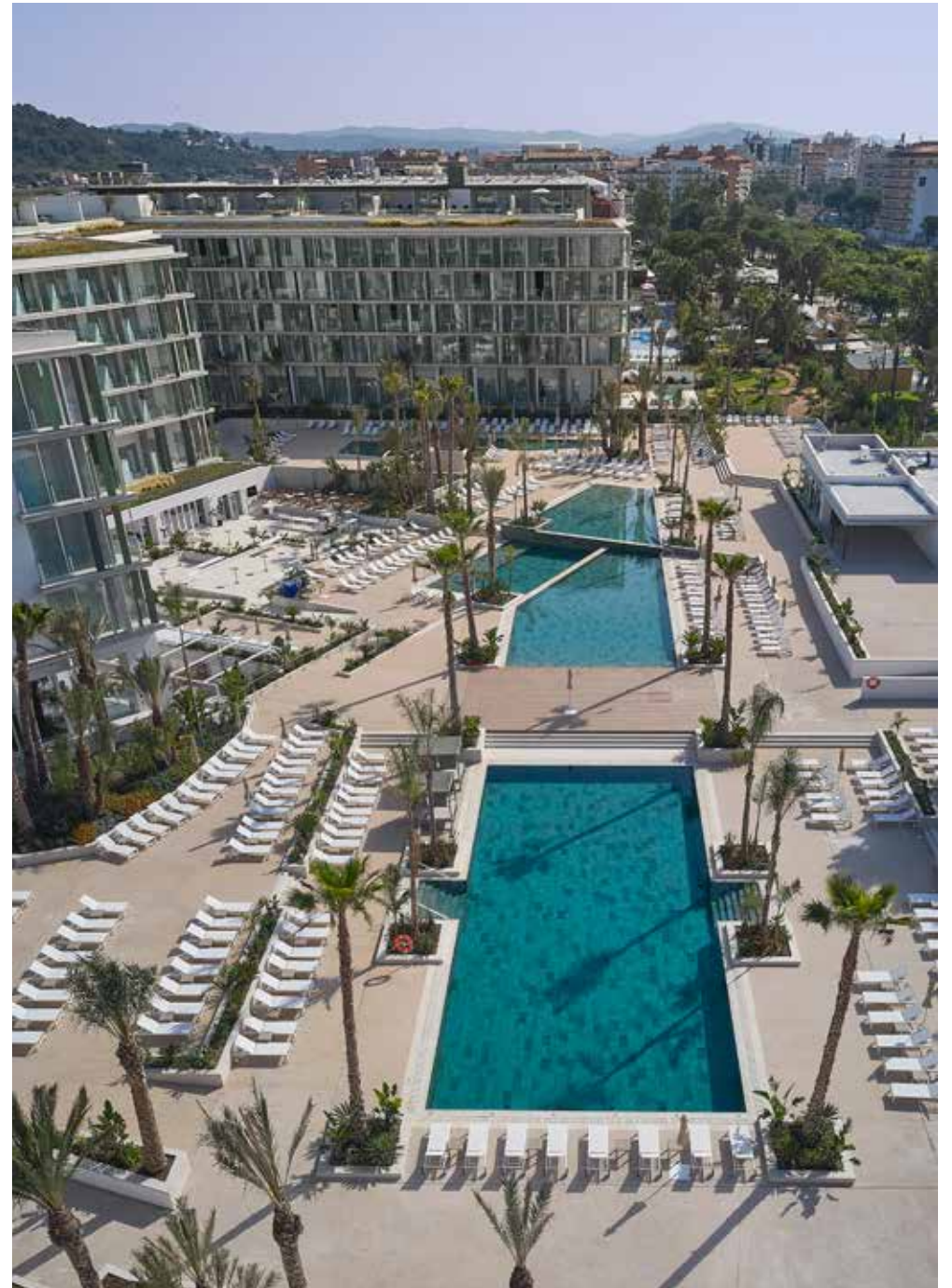



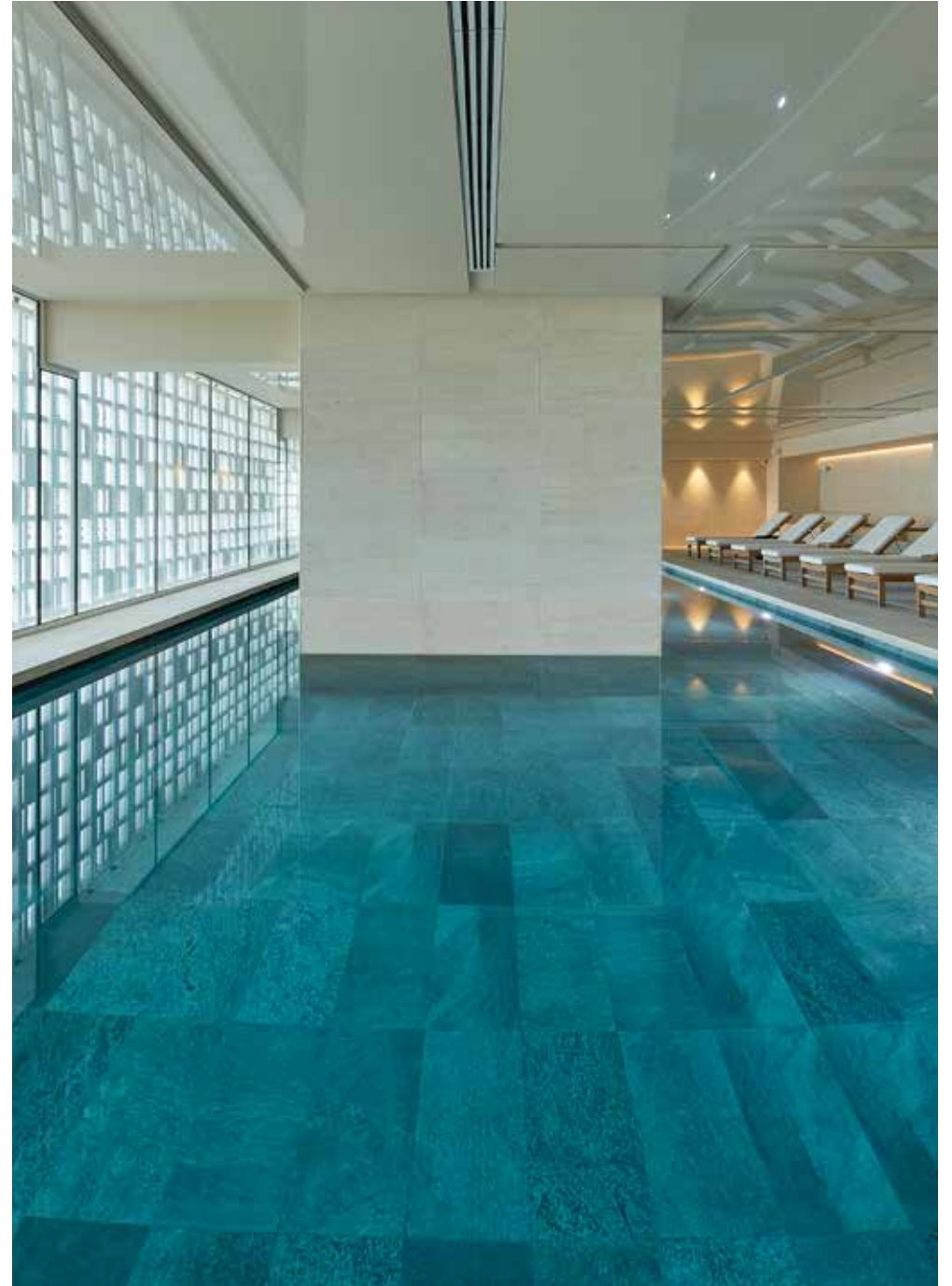























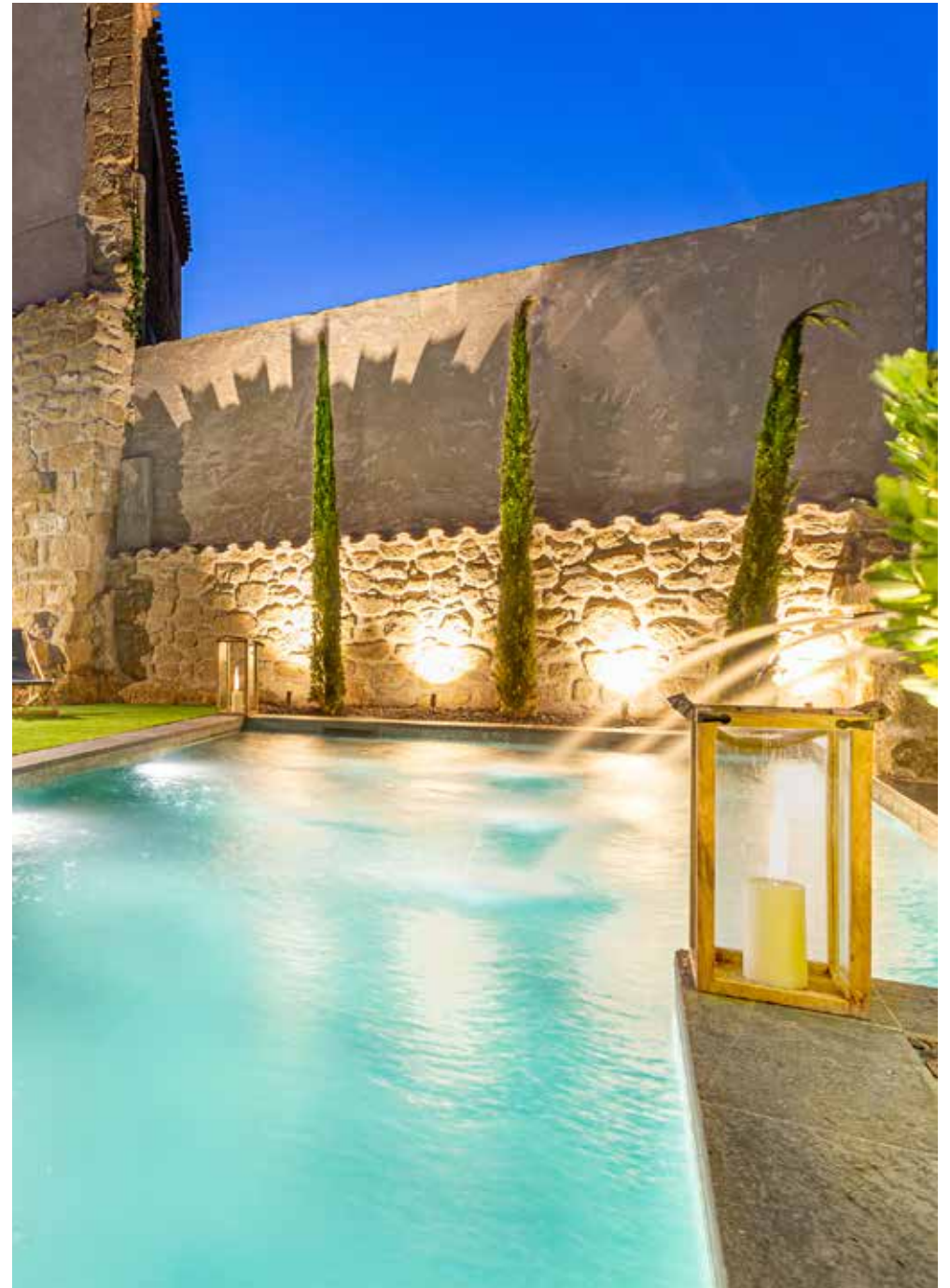













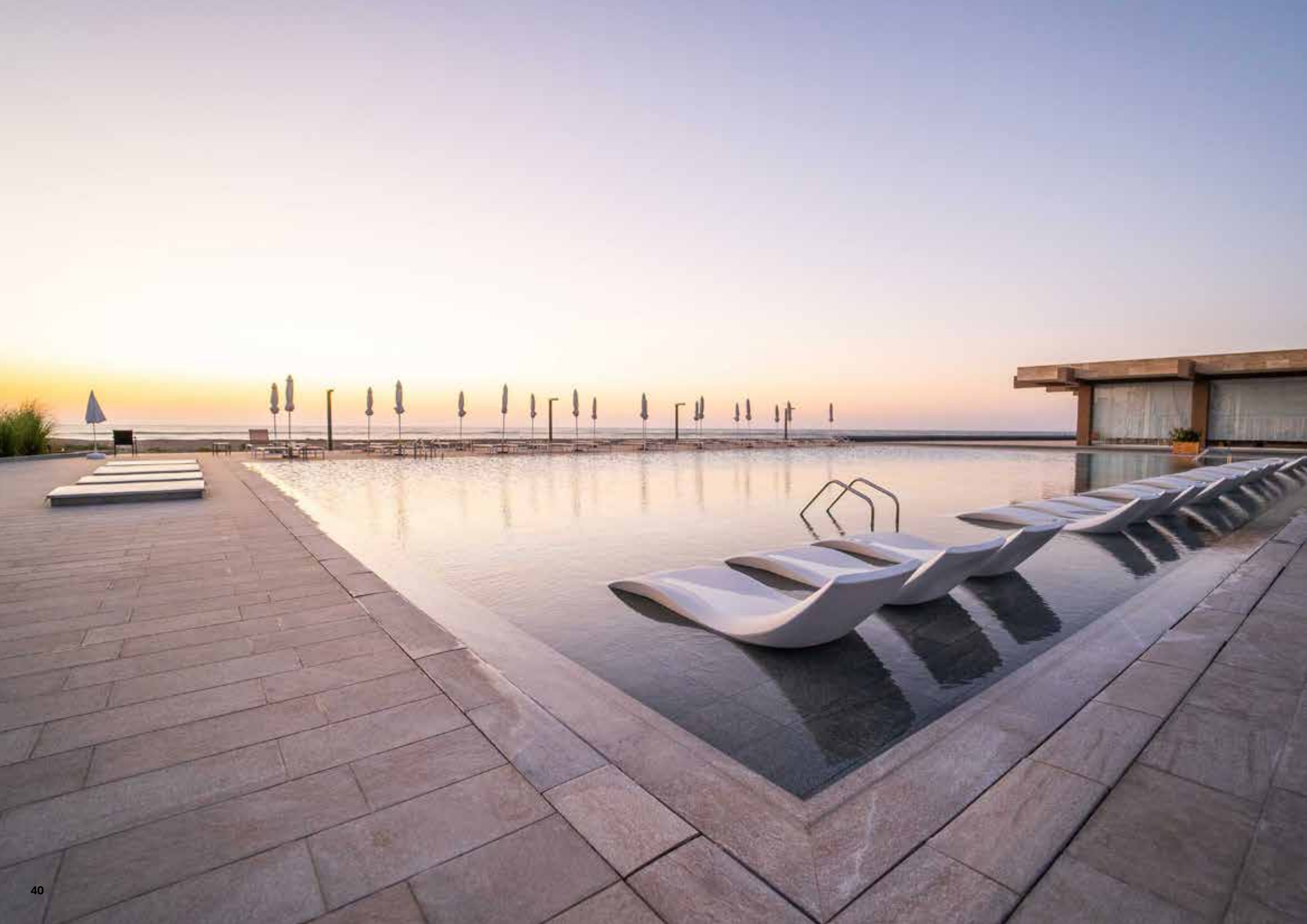











WALDDORF  
WELLNESS

WALDDORF  
WELLNESS

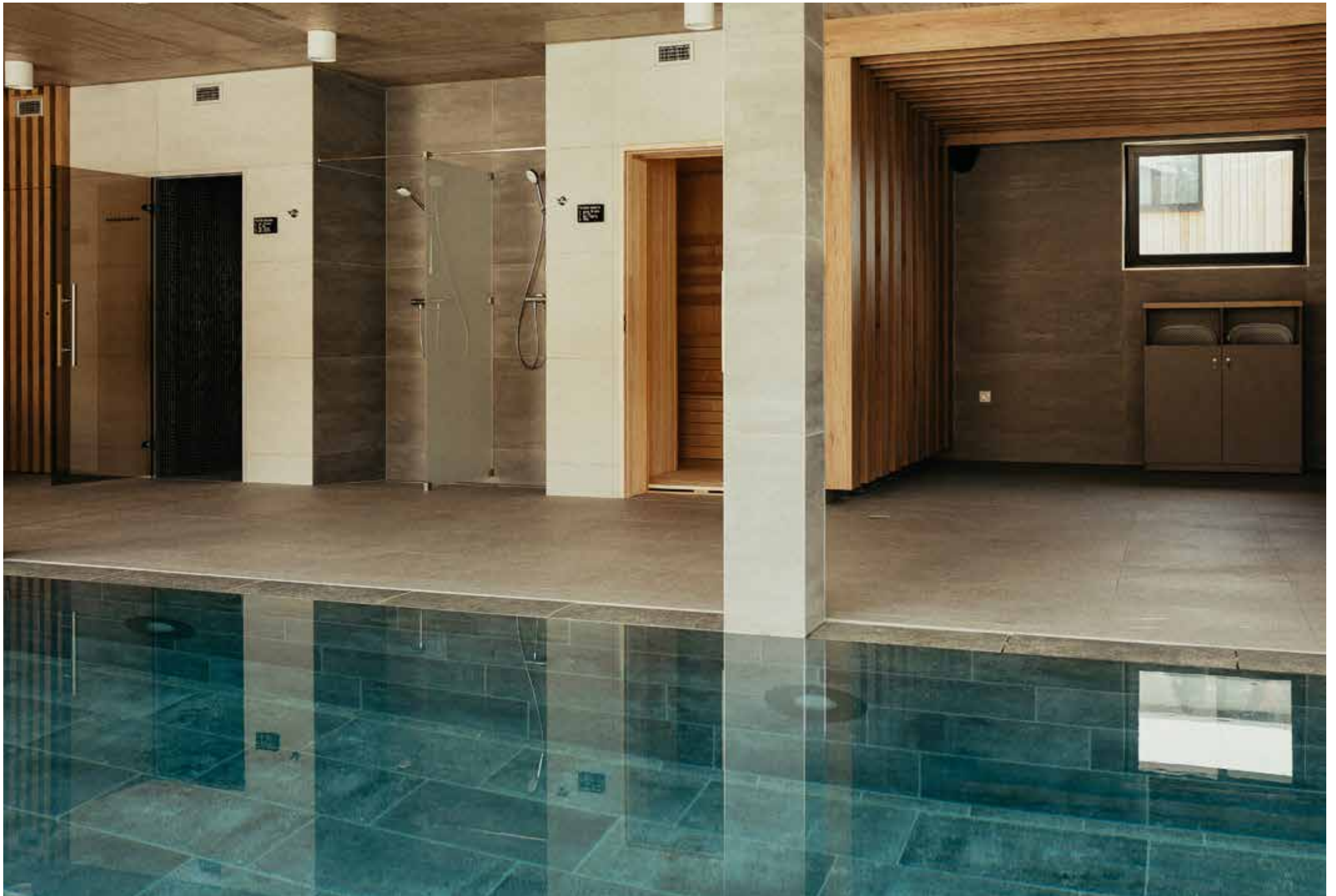









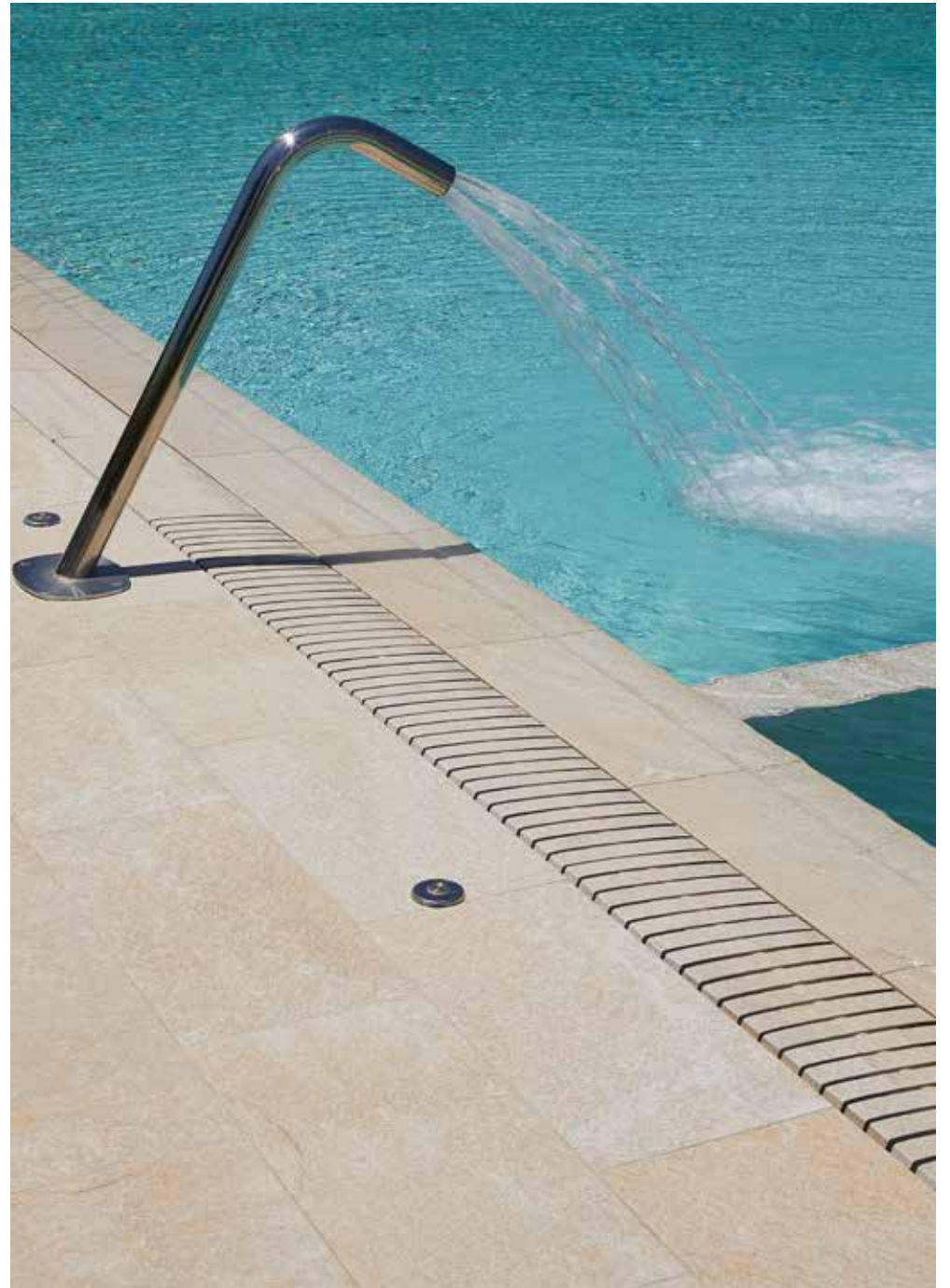



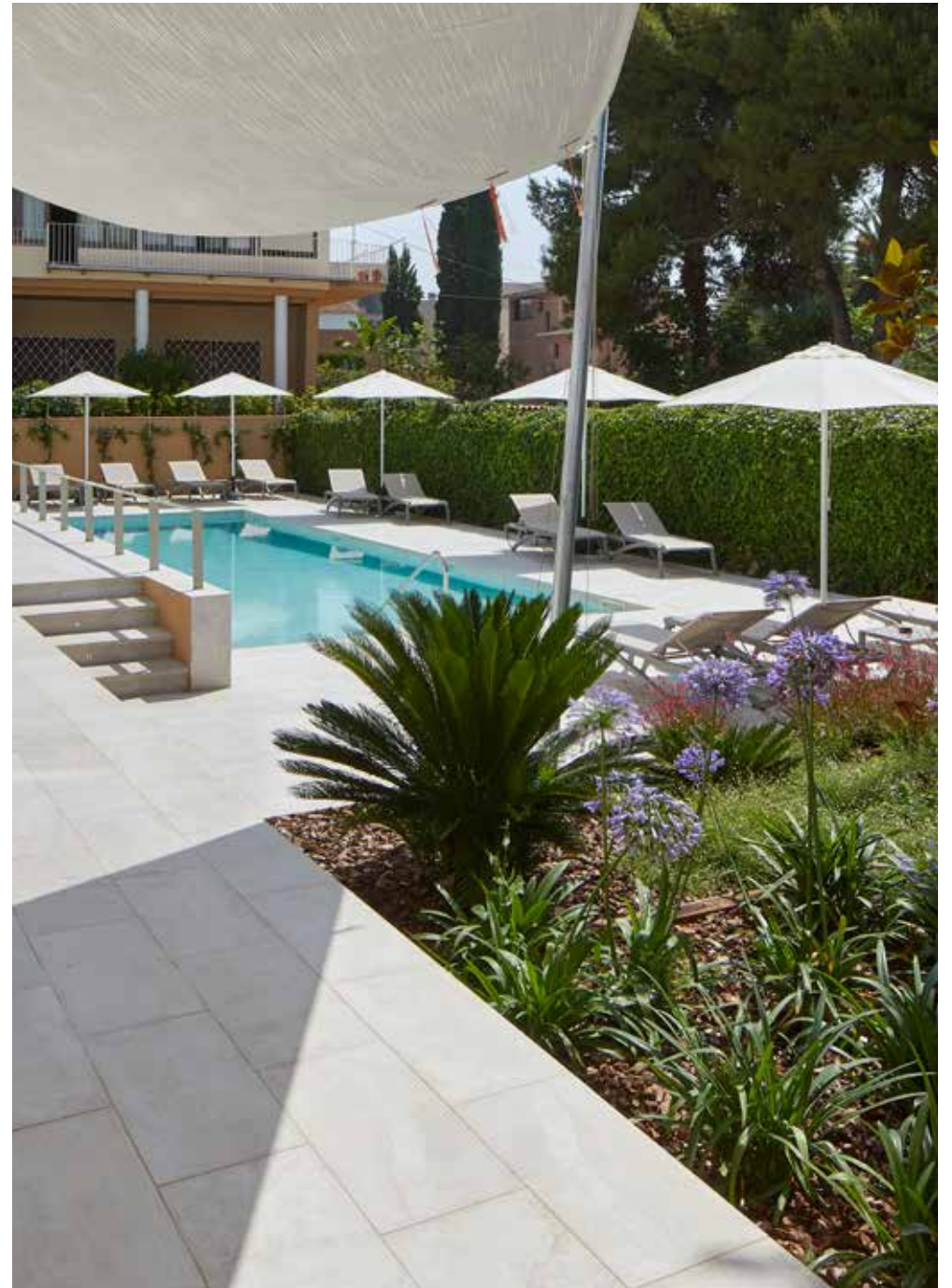



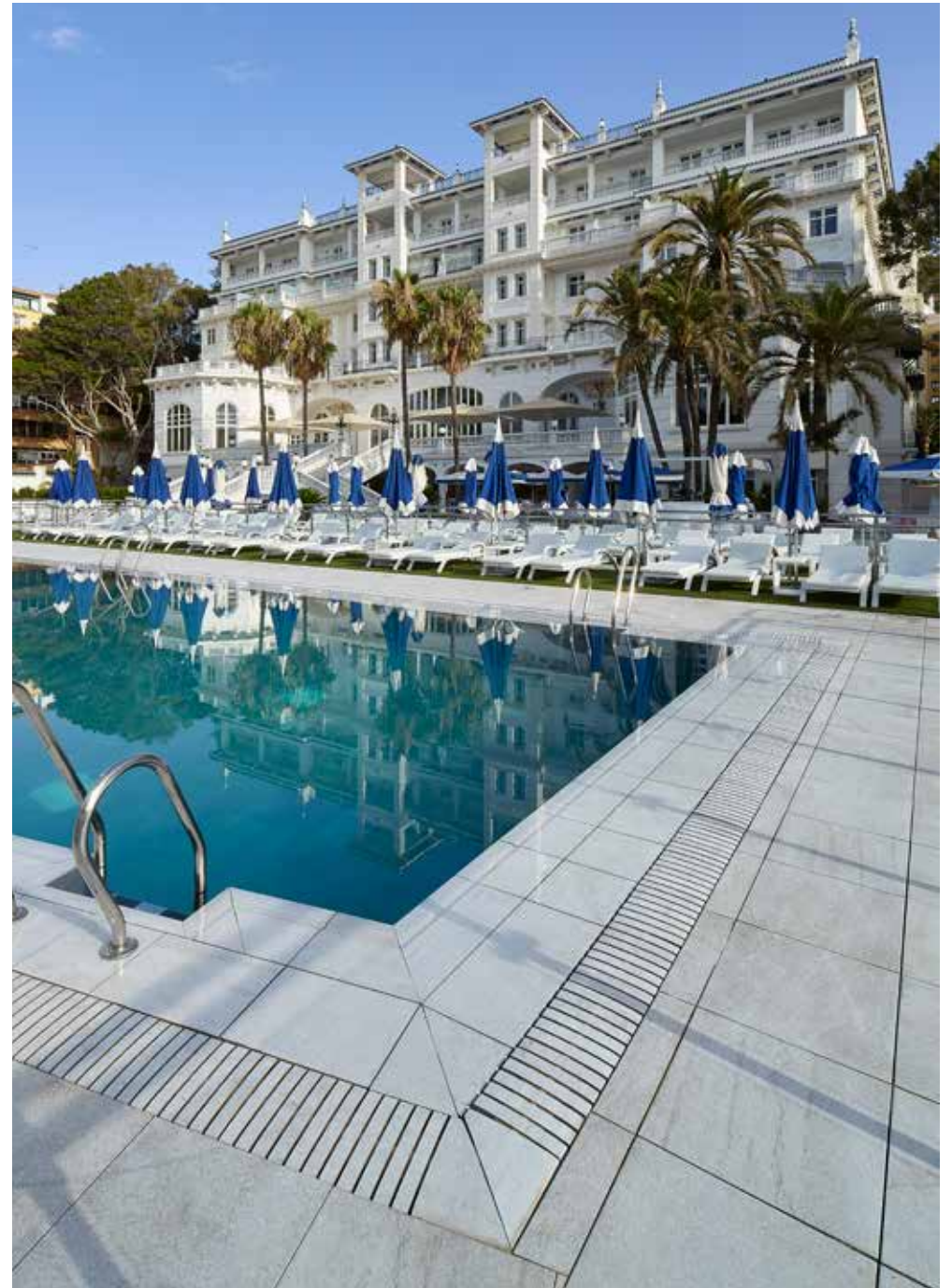



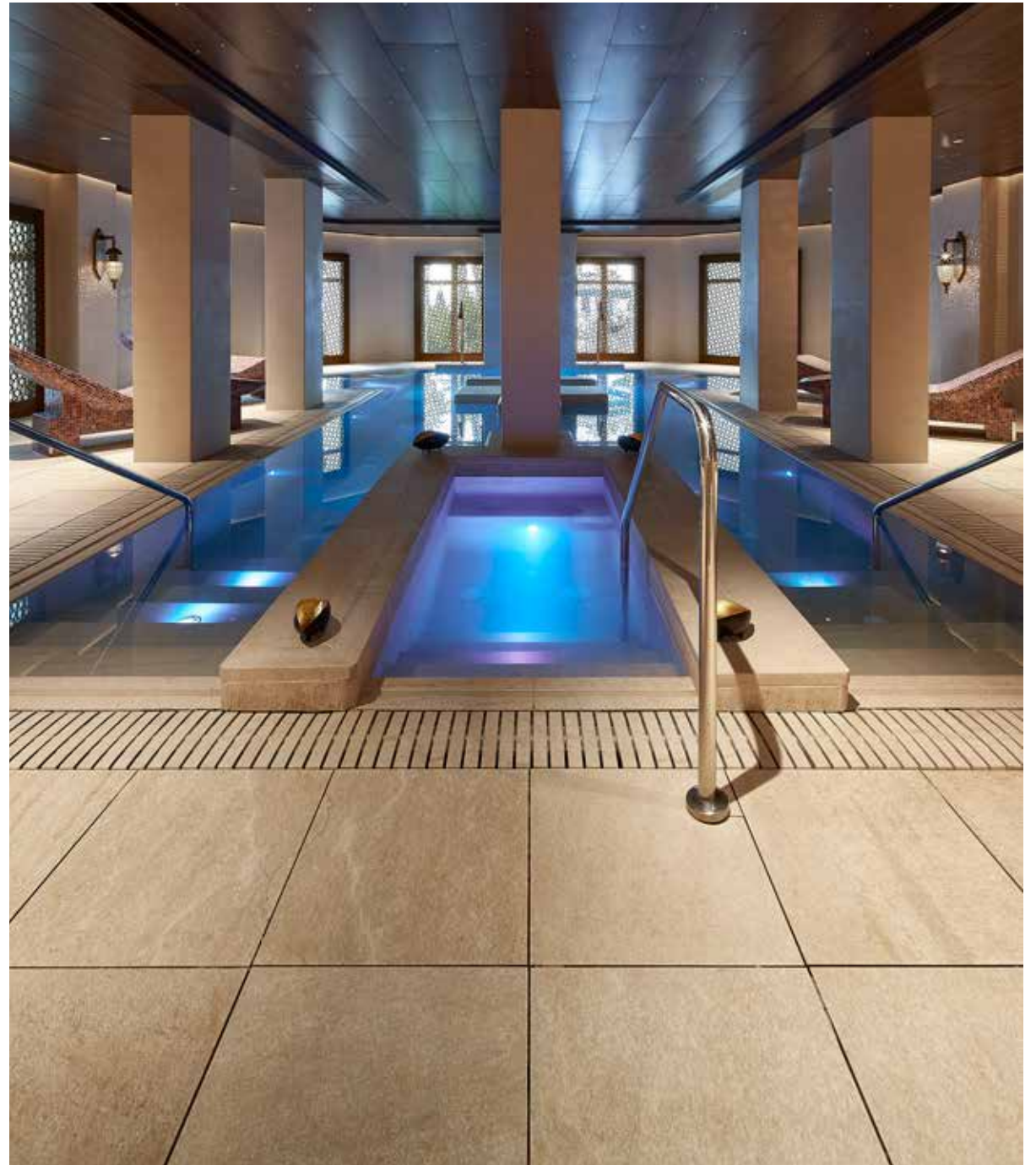
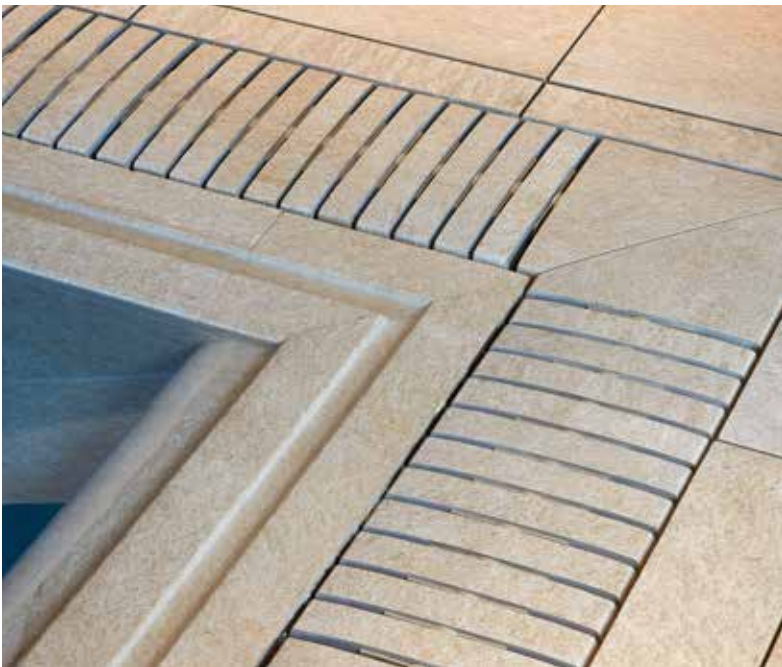





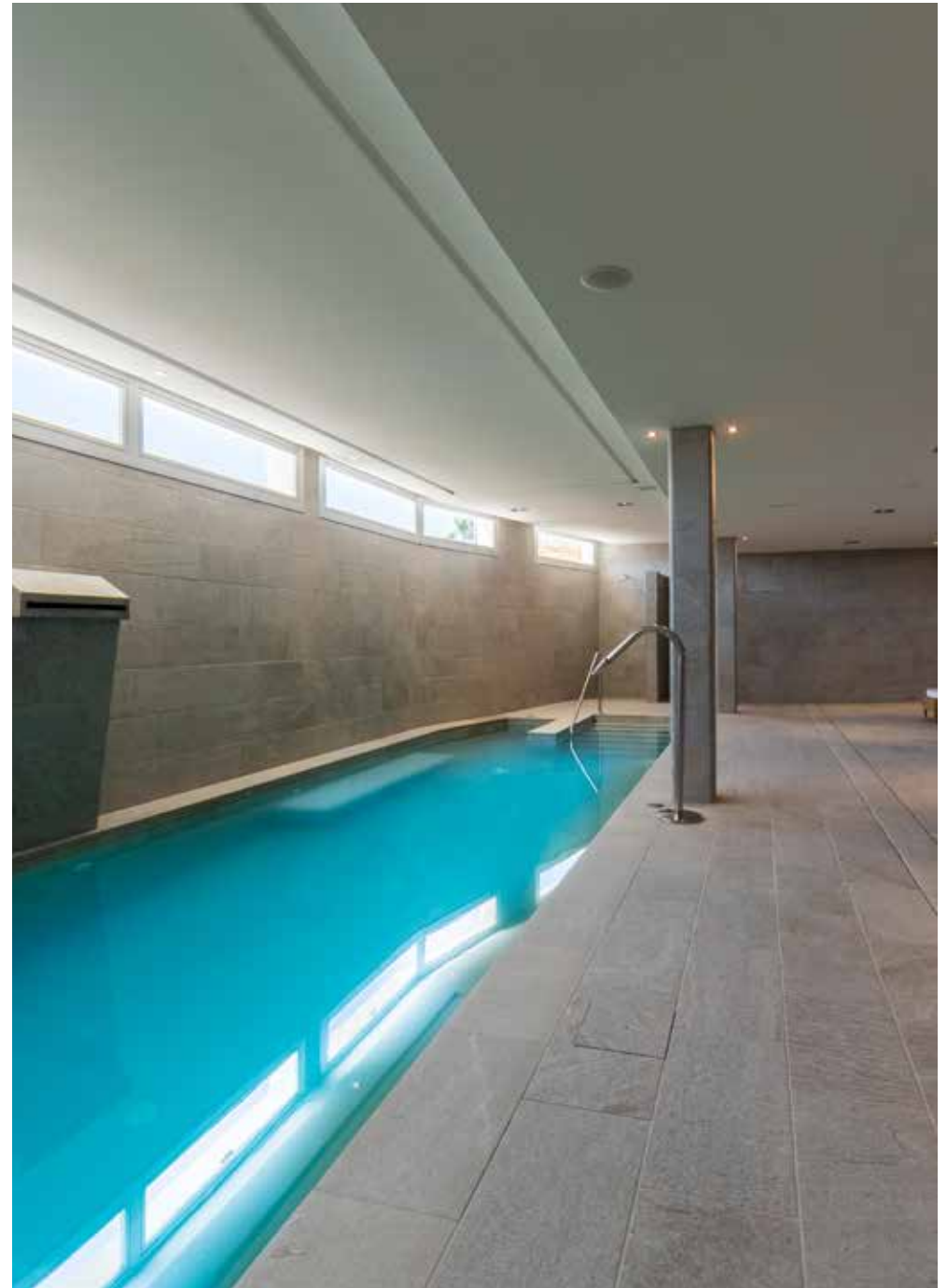

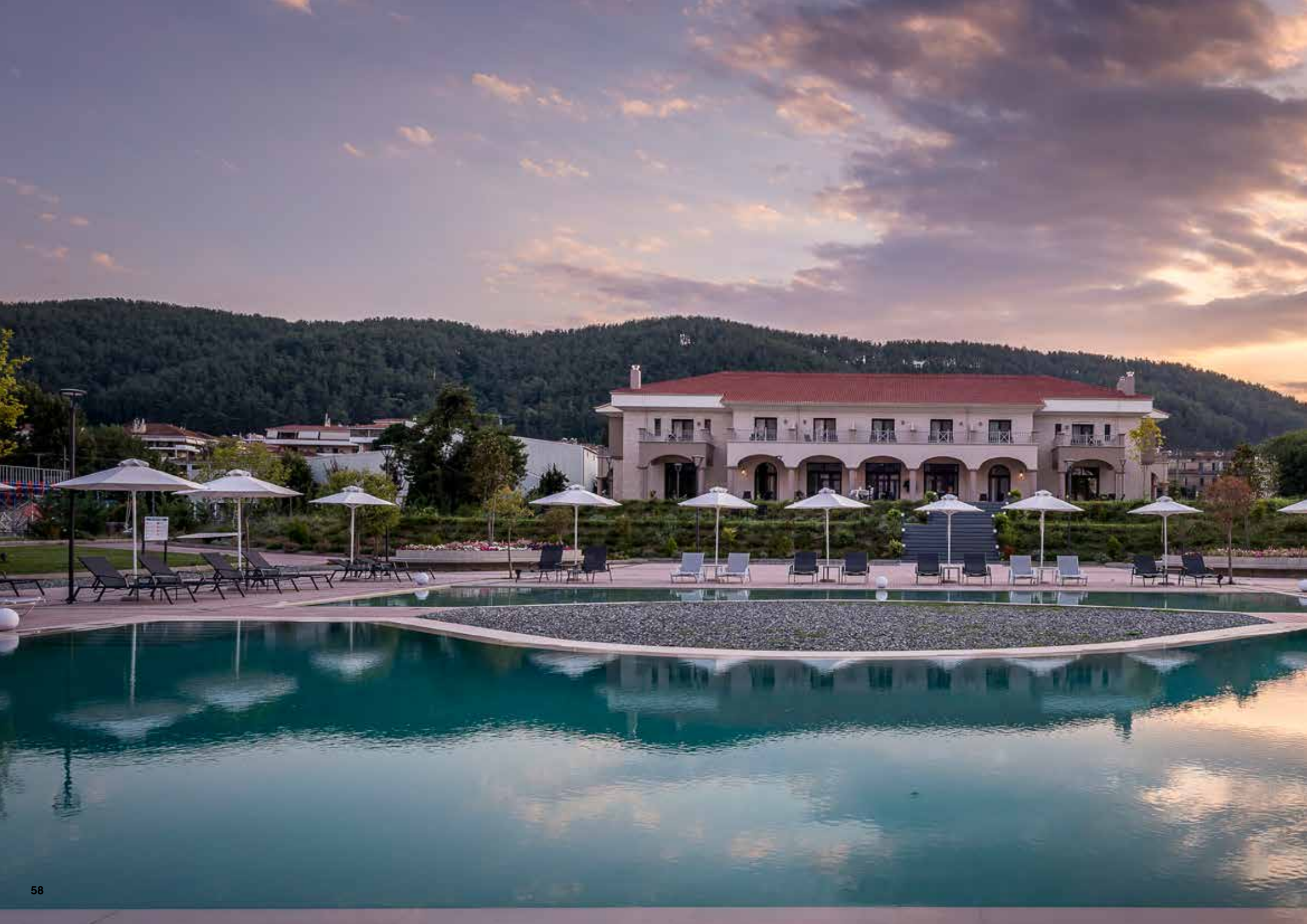

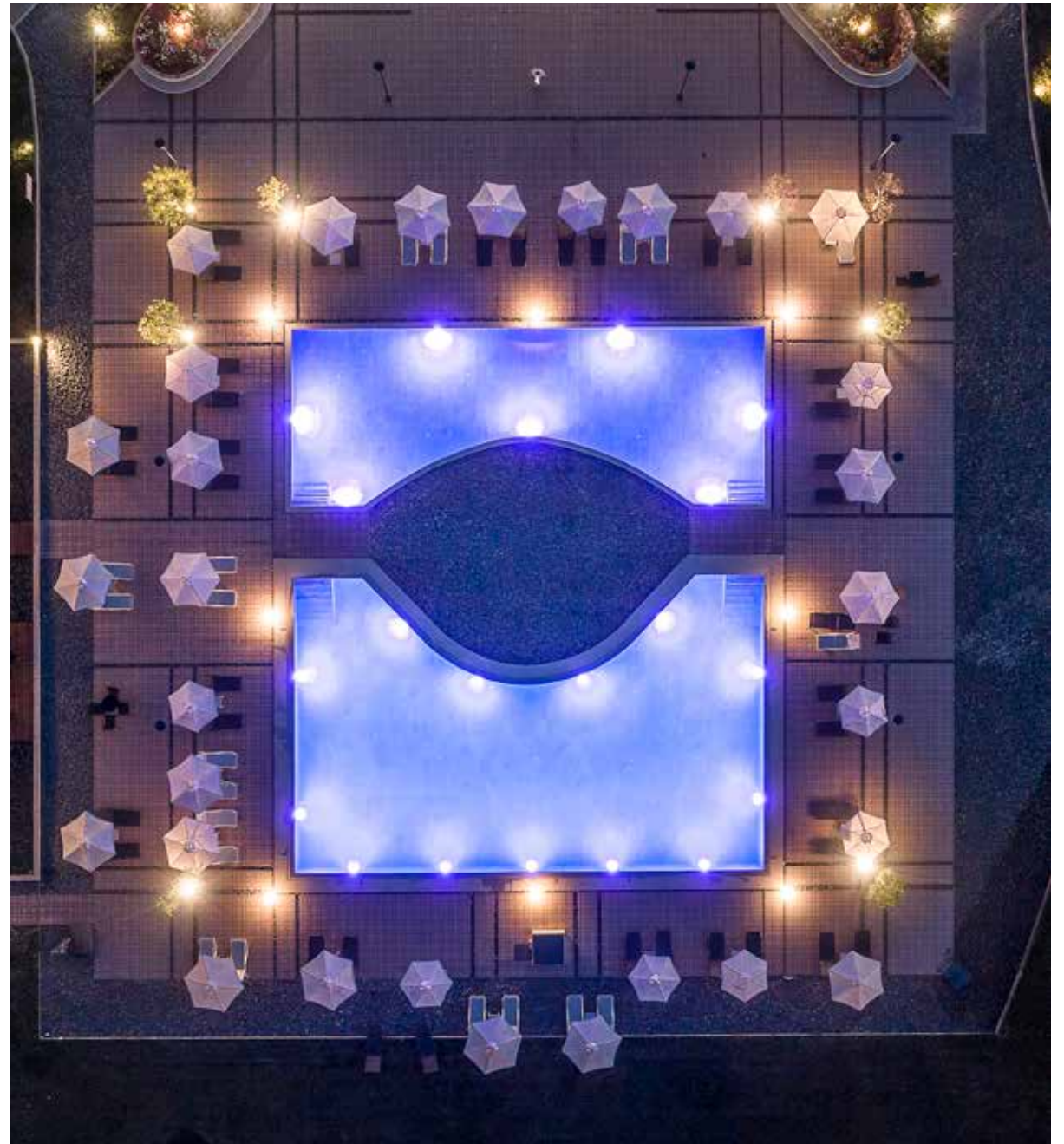

















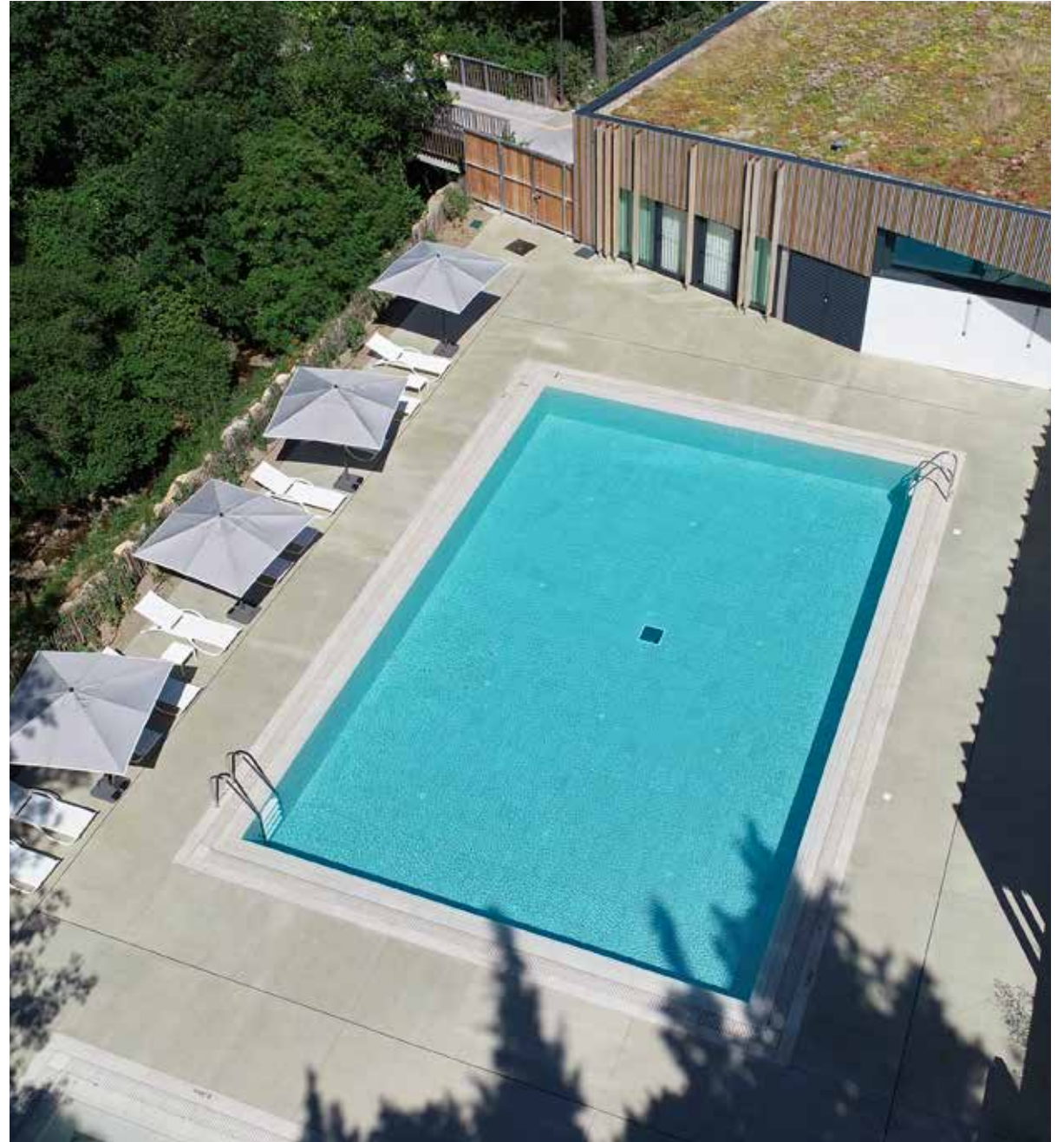







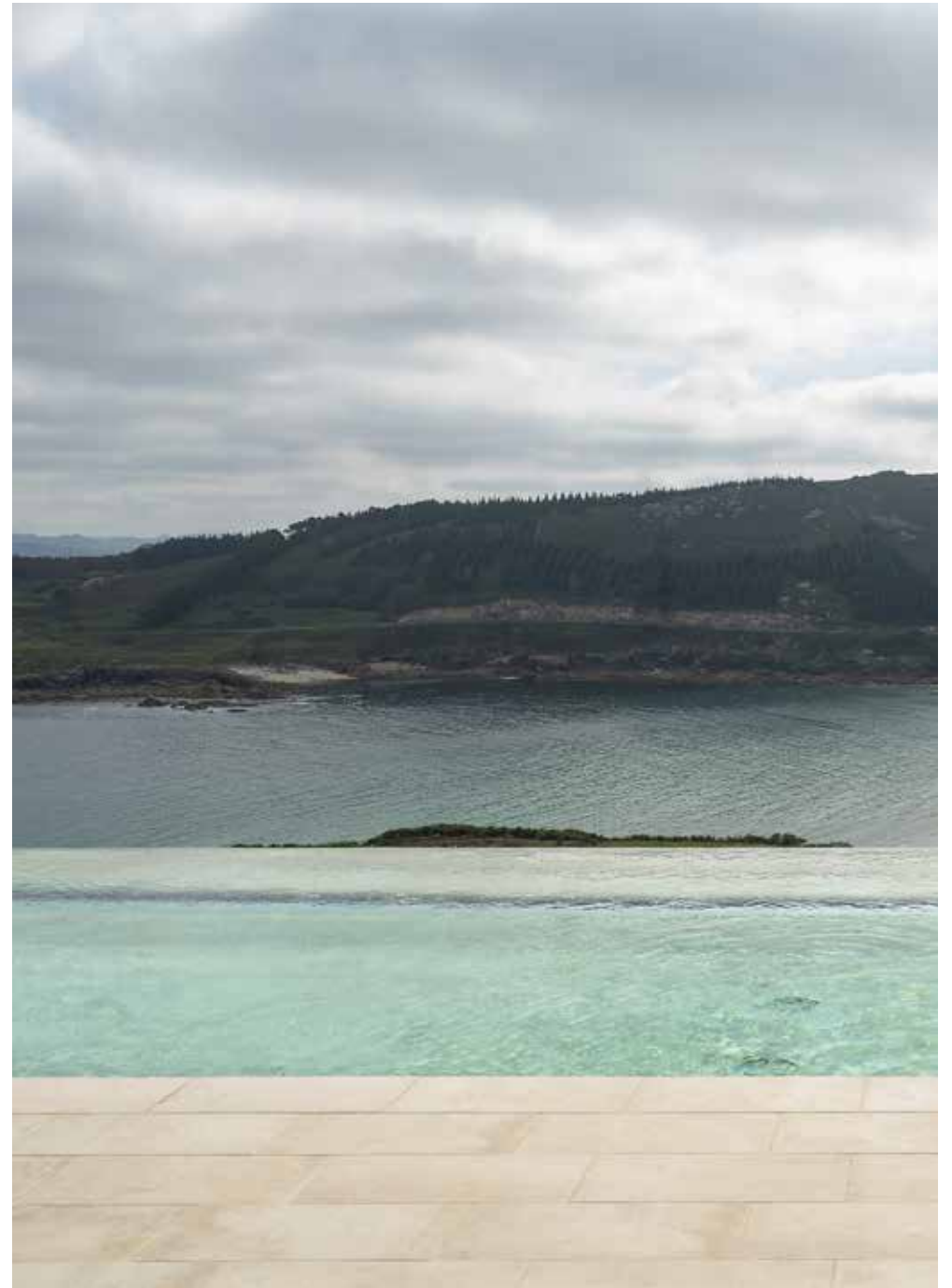





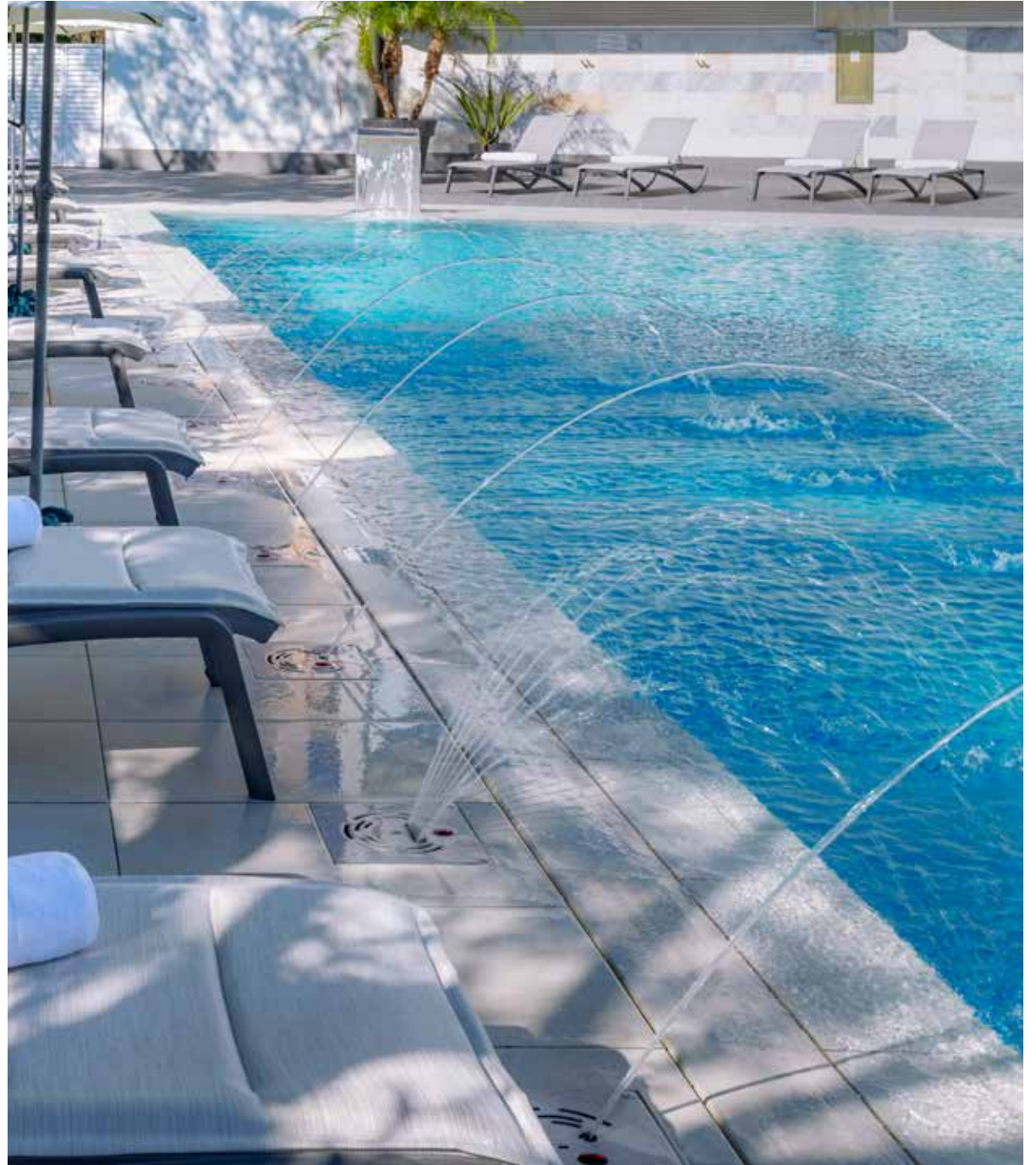







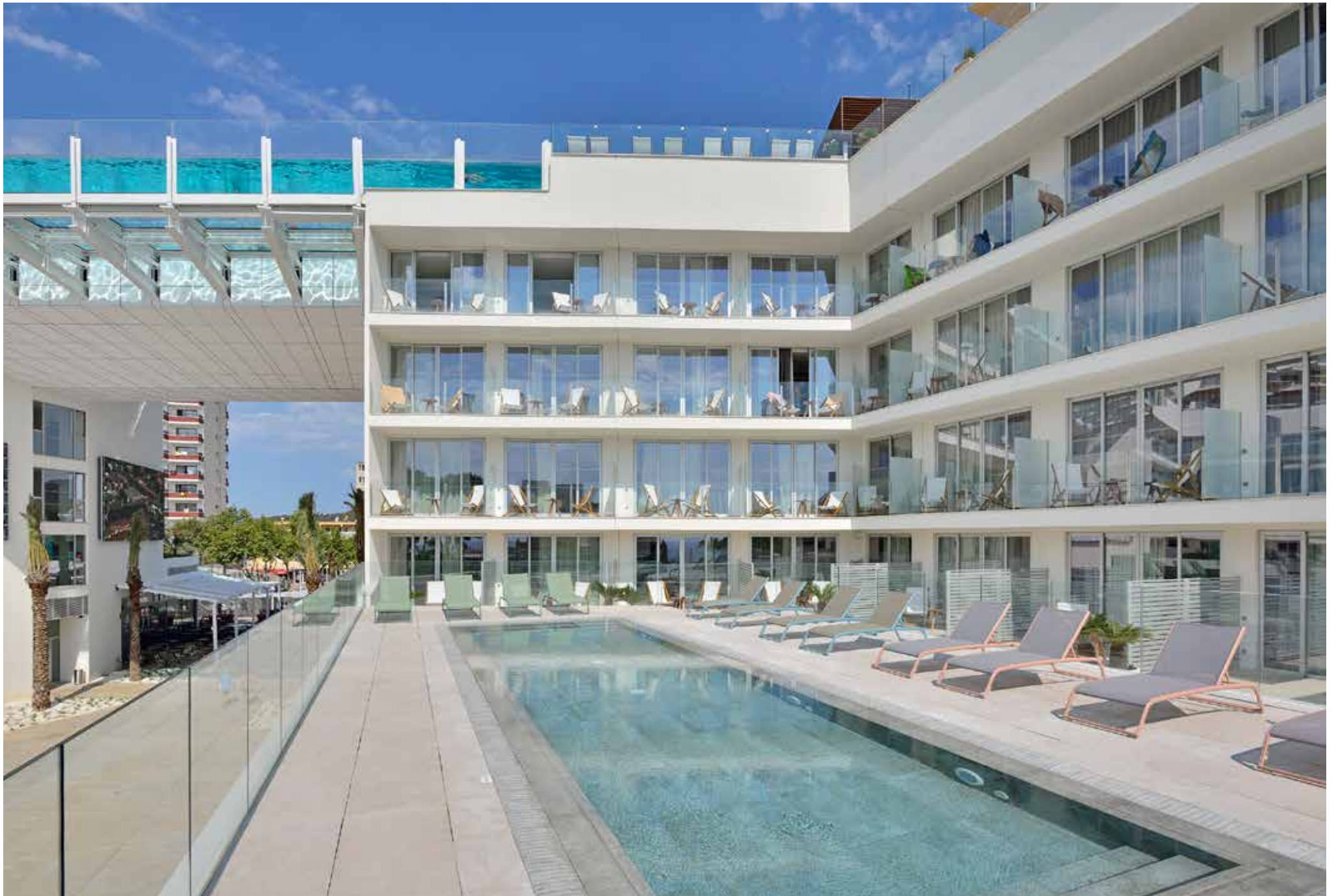

# dream team



## IMPLICADOS COMO UN VERDADERO PARTNER

Nuestro equipo técnico es experto en desarrollo y construcción de piscinas. Trabajamos con metodología BIM. Asesoramos a los profesionales y arquitectos durante todo el proceso constructivo.

## FULLY INVOLVED LIKE A TRUE PARTNER

Our technical team are experts in the design and construction of swimming pools. We work with BIM methodology. We consult with contractors and architects throughout the construction process.

## S'IMPLIQUER EN TANT QUE VERITABLE PARTENAIRE

Notre équipe technique est experte dans le développement et la construction de piscines. Nous travaillons avec la méthodologie BIM. Nous conseillons les professionnels et les architectes tout au long du processus de construction.

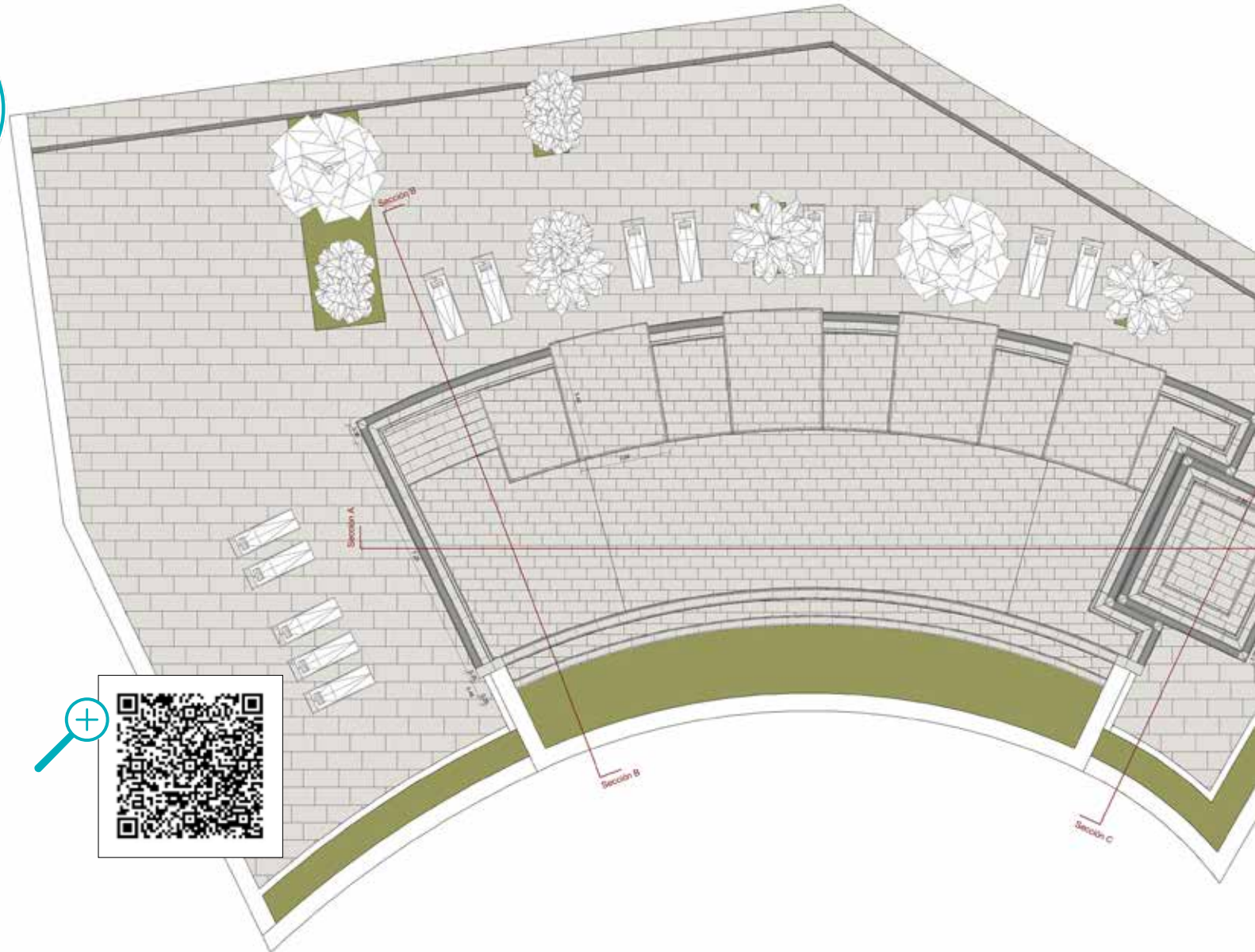



Royal Marina Suites Boutique Hotel | Puerto Calero, Lanzarote, Canary Islands, Spain



**DESCUBRE NUESTRA ZONA PROFESIONALES**

**DISCOVER OUR PROFESSIONALS AREA**

**DÉCOUVREZ NOTRE ESPACE PROFESSIONNEL**



**RECURSOS BIM + CAD**  
BIM + CAD RESOURCES  
RESSOURCES BIM + CAD



**SISTEMAS CONSTRUCTIVOS PARA PISCINAS**

CONSTRUCTION SYSTEMS FOR POOLS

SYSTÈMES DE CONSTRUCTION POUR PISCINES



**COLORES Y TEXTURAS DESCARGABLES**

COLORS AND TEXTURES AVAILABLE FOR DOWNLOAD

COULEURS ET TEXTURES TÉLÉCHARGEABLES



**FICHAS TÉCNICAS Y MEMORIAS DESCRIPTIVAS**

TECHNICAL DATA SHEETS AND SPECIFICATIONS

FICHES TECHNIQUES ET MÉMOIRES DESCRIPTIVES

# dream team



## **DISEÑAR, PROYECTAR CONSTRUIR, DISFRUTAR**

Para conseguir un acabado perfecto es imprescindible trabajar con las mejores soluciones constructivas. Sabemos que cada diseño es único. Contar con la experiencia de los productos **Fixcer** para la construcción nos garantiza el éxito final de todo el proyecto.

## **DESIGN, PLAN, BUILD, ENJOY**

Achieving the perfect finish is only possible with the best construction solutions. We know that each design is unique. Trust in the expertise of **Fixcer** products for construction guarantees the success of the entire project.

## **CONCEVOIR, PLANIFIER CONSTRUIRE, APPRÉCIER**

Pour obtenir une finition parfaite, il est essentiel de travailler avec les meilleures solutions de construction. Nous savons que chaque projet est unique. Faites confiance à l'expérience des produits **Fixcer** pour la construction garantit le succès final de l'ensemble du projet.

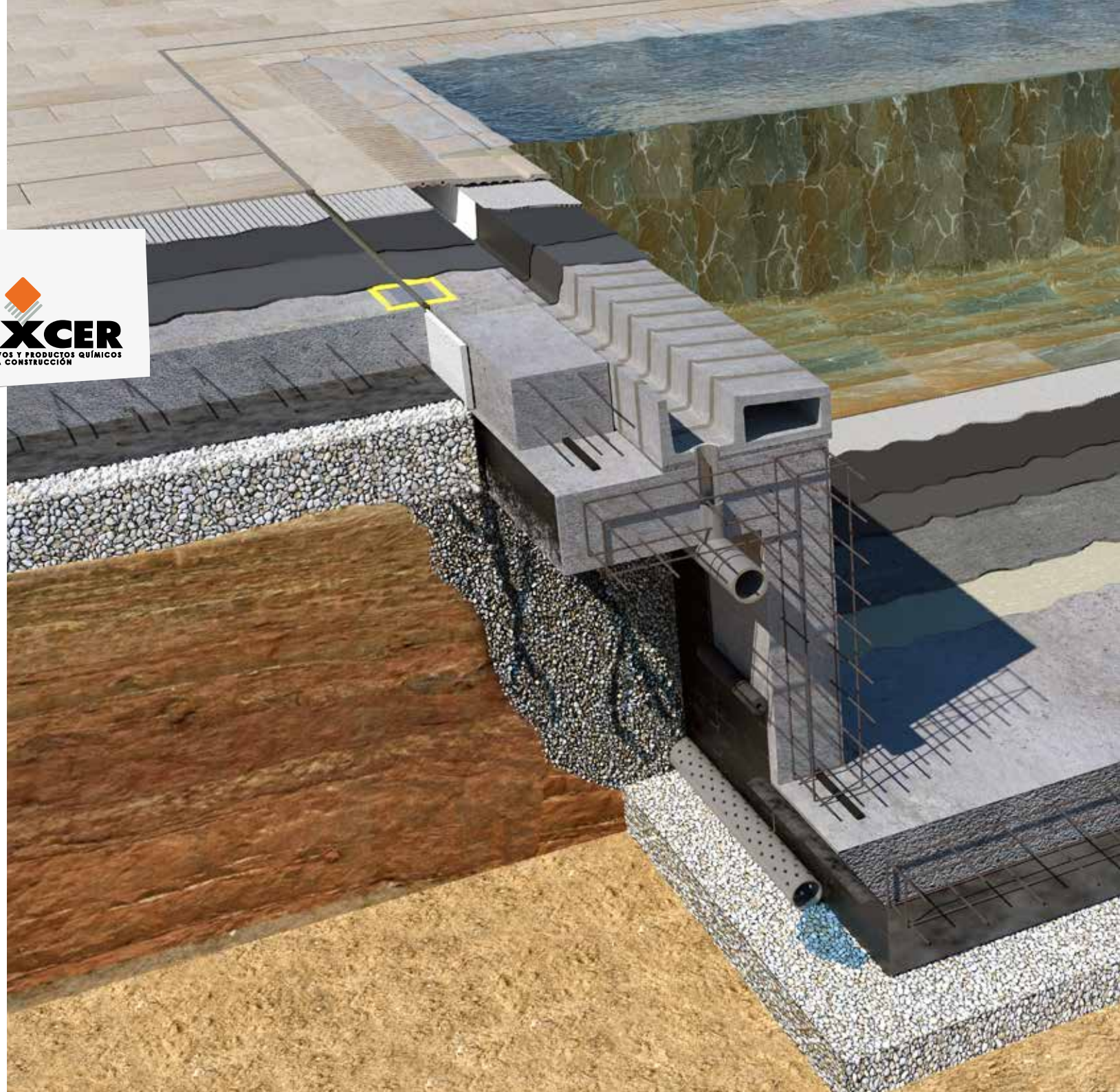





# zero problems pools

**PEGAR**  
**REJUNTAR**  
**IMPERMEABILIZAR**  
**SELLAR**  
**FIXING**  
**GROUTING**  
**WATERPROOFING**  
**SEALING**  
**COLLER**  
**JOINTOYER**  
**IMPERMÉABILISER**  
**SCELLER**

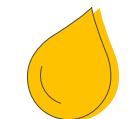

**ZERO FUGAS**  
**PISCINA 100% ESTANCA**  
**ZERO LEAKS**  
**100% WATERTIGHT POOLS**  
**ZÉRO FUITE**  
**PISCINE 100% ÉTANCHE**

**MÁS DE 1.000.000 de m²**  
**DE PISCINAS REALIZADOS**  
**OVER 1,000,000 m²**  
**OF POOL INSTALLATIONS**  
**PLUS DE 1.000.000 m²**  
**DE PISCINES RÉALISÉES**

**CONSUMO DEL AGUA**  
**MÁS SOSTENIBLE**  
**MORE SUSTAINABLE**  
**USE OF WATER**  
**UTILISATION PLUS**  
**RESPONSABLE DE L'EAU**

**LA SOLIDEZ CONSTRUCTIVA**  
**ALARGA LA VIDA DE LA PISCINA**  
**SOLID CONSTRUCTION FOR GREATER**  
**DURABILITY**  
**LA SOLIDITÉ DE LA CONSTRUCTION**  
**PROLONGE LA DURÉE DE VIE DE LA PISCINE**

**REDUCCIÓN DE LOS COSTES**  
**DE MANTENIMIENTO**  
**REDUCED**  
**MAINTENANCE COSTS**  
**RÉDUCTION DES**  
**COÛTS D'ENTRETIEN**

**FABRICACIÓN SOSTENIBLE**  
**NORMA EN14.001**  
**SUSTAINABLE MANUFACTURING**  
**STANDARD EN14.001**  
**FABRICATION DURABLE**  
**NORME EN14.001**

# MAXIMUM SAFETY

**Rosa Gres** fabrica uno de los acabados antideslizantes de gres porcelánico más seguros del mercado. Es agradable al tacto y fácil de limpiar. **¿Cómo funciona?** Al pisar el pavimento húmedo se produce un efecto ventosa y de agarre al suelo que evita el deslizamiento

**Rosa Gres** produces one of the safest non-slip porcelain stoneware surfaces on the market. It is pleasant to the touch and easy to clean. **How does it work?** When stepping on the wet tile, it produces a suction and grip effect that prevents slipping.

**Rosa Gres** fabrique l'un des revêtements de sol antidérapants en grès cérame les plus sûrs du marché. C'est un matériau agréable au toucher et facile à nettoyer. **Comment fonctionne-t-il ?** Le fait de marcher sur le sol mouillé produit un effet d'aspiration et d'adhérence qui empêche de glisser.





# SOLAR REFLEC TANCE IRS

El gres porcelánico Rosa Gres expuesto a la luz del sol presenta un excelente comportamiento atérmico. En todos los casos, los colores claros se calientan menos que los colores oscuros.

Rosa Gres porcelain stoneware has excellent Solar Reflectance Index. Lighter colors always heat up less than darker colors.

Le grès cérame Rosa Gres exposé à la lumière du soleil a un excellent comportement thermique. Dans tous les cas, les couleurs claires se réchauffent moins que les couleurs foncées.

# MAXIMUM SECURITY

NEW

## **NUEVO ACABADO ANTIDESLIZANTE PASTILLA**

Nuevos colores con el acabado pastilla. Es ideal para zonas con tránsito descalzo y presencia de agua. Con los nuevos colores, el acabado pastilla se viste de diseño.

## **NEW NON-SLIP "PASTILLA" FINISH**

New colors available with the diamond finish. Ideal for areas with barefoot traffic and the presence of water. These new colors add a designer touch to the Pastilla finish.

## **NOUVELLE FINITION ANTIDÉRAPANTE "PASTILLA"**

Nouvelles couleurs avec la finition structurée. Elle est idéale pour les zones où l'on circule pieds nus et où il y a de l'eau. Avec les nouvelles couleurs, la finition tablette s'habille de design.

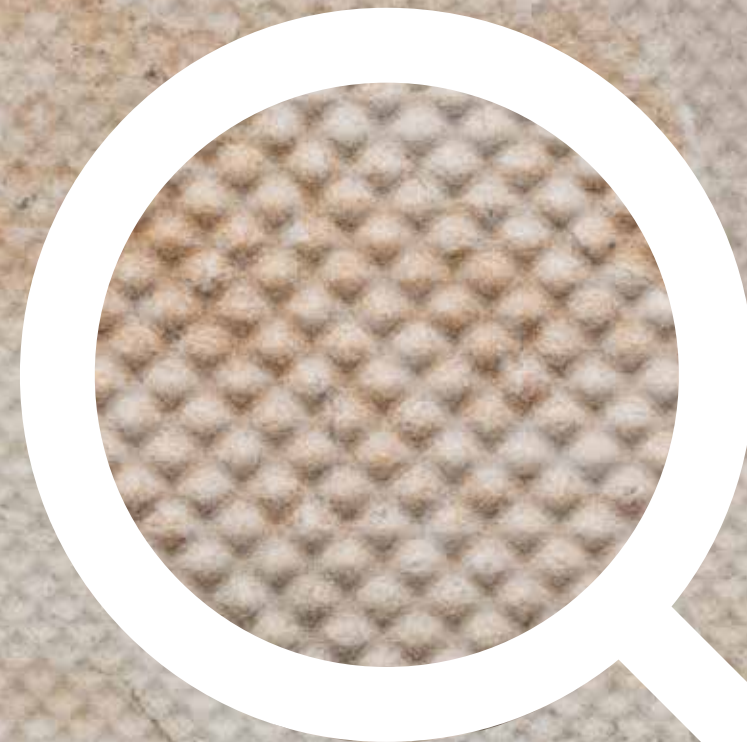



**Pietro White Pastilla 31 x 62,6**



**Pietro Golden Pastilla 31 x 62,6**



**Pietro Grey Pastilla 31 x 62,6**



**Pietro Dark Pastilla 31 x 62,6**



**Iconic White Pastilla 31 x 62,6**



**Iconic Grey Pastilla 31 x 62,6**



**Iconic Dark Pastilla 31 x 62,6**

EN 16165  
(DIN 51097)  
Anexo A

CLASE C  
≥ 24°

EN 16165  
(DIN51130)

R11  
> 19° - 27°

DIN51130

V4

EN 16165  
(UNE 41901)

CLASE 3  
RD > 45

EVITA  
EL EFECTO  
"AQUAPLANING"  
CON PIE  
DESNUDO

ELIMINATE THE  
AQUAPLANING  
EFFECT WITH  
BARE FEET

CELA PERMET  
D'ÉVITER  
"L'AQUAPLANING"  
PIEDS NUS

# ECO design

## Draining pavement



### **NUEVO PAVIMENTO DRENANTE DE DISEÑO**

- No rompe el ciclo del agua
- No necesita pendientes ni canalizaciones
- Alta capacidad drenante
- Juntas resistentes, sin mantenimiento
- Acabado porcelánico de diseño Rosa Gres

### **NEW DESIGNER FLOORING WITH DRAINAGE**

- Does not disrupt the water cycle
- No need for slopes or channels
- High drainage capacity
- Durable joints, no maintenance
- Rosa Gres designer porcelain stoneware finish

### **SOL PER CHAUSSÉE DRAINANTE NOUVELLE CONCEPTION**

- Ne rompt pas le cycle de l'eau
- Pas besoin de pentes ou de canalisations
- Grande capacité de drainage
- Joints résistants sans entretien
- Finition en grès cérame design Rosa Gres



# 1

Sanear y nivelar el terreno.  
Colocar la capa de grava.

Prepare and level the site.  
Lay the gravel.

Nettoyer et niveler le sol.  
Poser la couche de gravier.



# 2

Aplicar MORTER DRAIN regleado encima de la grava.

Apply MORTER DRAIN over the gravel.

Appliquer MORTER DRAIN sur le gravier.



# 3

Una vez aplicado dejar fraguar el mortero, cubriéndolo con un plástico durante 48 horas.

Once applied, leave the mortar to set and cover with plastic for 48 hours.

Une fois le mortier appliqué, il faut le laisser durcir en le recouvrant d'un film plastique pendant 48 heures.



# 4

Pegar las piezas de gres porcelánico con cemento cola FIXAFLEX GEL manteniendo el ancho de la junta necesario según los requisitos de drenaje previstos.

Fix the porcelain stoneware pieces with FIXAFLEX GEL tile adhesive, maintaining the required joint width according to the drainage requirements.

Coller les pièces en grès cérame avec le ciment-colle FIXAFLEX GEL en respectant la largeur de joint nécessaire en fonction des exigences de drainage.



# 5

Pasadas 24 horas rejuntar con JUNTA DRAIN.

After 24 hours, grout with JUNTA DRAIN.

Après 24 heures, jointoyer avec JUNTA DRAIN



# 6

Al cabo de 24 horas el suelo ya es totalmente utilizable.

Flooring is fully usable after 24 hours.

Après 24 heures, le sol est entièrement utilisable.



¿Cómo funciona?  
VER VIDEO

How does it work?  
WATCH VIDEO

Comment cela  
fonctionne-t-il ?  
VOIR LA VIDEO

CONSTRUCCIÓN INDUSTRIALIZADA DE PISCINAS  
 INDUSTRIALIZED POOL CONSTRUCTION  
 CONSTRUCTION INDUSTRIALISÉE DE PISCINES



## SISTEMA 9

Coronamiento prefabricado formado por bloques de hormigón hidrófugo. Cada pieza funciona como canal y soporte de la cerámica. Se integra perfectamente con todos nuestros Sistemas Desbordantes.

## THE 9 SYSTEM

Prefabricated overflow channel of water resistant concrete blocks. Each piece acts as a channel and support for the ceramic tile. Integrates perfectly with all our overflow systems.

## SYSTÈME 9

Canal fabricado en bloques de béton hidrofuges. Chaque pièce sert de canal et de support pour les céramiques. Elle s'intègre parfaitement à tous nos systèmes à débordement.



AHORRO DE TIEMPO, MANO DE OBRA Y RECURSOS

SAVINGS IN TIME, LABOR AND RESOURCES

ÉCONOMISER DU TEMPS, DE LA MAIN-D'ŒUVRE ET DES RESSOURCES



EL SISTEMA DE COLOCACIÓN REDUCE LA CREACIÓN DE RESIDUOS

PLACEMENT SYSTEM REDUCES WASTE

LE SYSTÈME DE PLACEMENT RÉDUIT LA PRODUCTION DE DÉCHETS



ACABADO PERFECTO DE LA CORONACIÓN DE LA PISCINA

PERFECT FINISH FOR THE POOL COPING

FINITION PARFAITE DE LA MARGELLE DE LA PISCINE



ELIMINA LAS DEFICIENCIAS PRODUCIDAS POR EL ENCOFRADO

ELIMINATES DEFECTS CAUSED BY THE FORMWORK

ÉLIMINE LES DÉFICIENCES CAUSÉES PAR LE COFFRAGE



AUMENTA LA ESTÉTICA VISUAL Y EL BIENESTAR

ENHANCES VISUAL AESTHETICS AND COMFORT

AMÉLIORE L'ESTHÉTIQUE VISUELLE ET LE BIEN-ÊTRE



ZERO FUGAS. MÁS HIGIENE. MENOS PRODUCTOS PARA LA DEPURACIÓN

ZERO LEAKS, IMPROVED HYGIENE, FEWER PURIFICATION PRODUCTS

ZÉRO FUITE. PLUS D'HYGIÈNE. MOINS DE PRODUITS DE PURIFICATION.



ENCAJA CON LAS MÚLTIPLES PIEZAS DE ACABADO ROSA GRES

COMPATIBLE WITH A WIDE RANGE OF ROSA GRES FINISHING PIECES

S'ADAPTE AUX MULTIPLES PIÈCES DE FINITION ROSA GRES



LA CERÁMICA ROSA GRES AUMENTA EL CICLO DE VIDA DE LA PISCINA

ROSA GRES STONEWARE PROLONGS THE LIFE OF THE POOL

LA CÉRAMIQUE ROSA GRES AUGMENTE LA DURÉE DE VIE DE LA PISCINE





CONSTRUCCIÓN  
INDUSTRIALIZADA  
DE PISCINAS  
INDUSTRIALIZED POOL  
CONSTRUCTION  
CONSTRUCTION  
INDUSTRIALISÉE  
DE PISCINES



100% ESTANCA.  
SIN FUGAS. GARANTIZADO.

100 % WATERTIGHT.  
NO LEAKS. GUARANTEED.

100 % ÉTANCHE.  
SANS FUITE. GARANTI.



PRESUPUESTO  
SIN "SORPRESAS"

QUOTATION WITHOUT  
ANY "SURPRISES"

DEVIS  
"SANS SURPRISE"



MÁXIMA  
DURABILIDAD

MAXIMUM  
DURABILITY

DURABILITÉ  
MAXIMALE



EJECUCIÓN EN  
TIEMPO RÉCORD

PROJECT COMPLETION  
IN RECORD TIME

EXÉCUTION EN  
UN TEMPS RECORD



MAYOR INERCIA  
TÉRMICA

INCREASED  
THERMAL INERTIA

INERTIE THERMIQUE  
RENFORCÉE



MÁXIMA PRECISIÓN  
EN LA EJECUCIÓN

MAXIMUM PRECISION IN  
CONSTRUCTION

PRÉCISION MAXIMALE DANS  
L'EXÉCUTION



HOMOLOGACIÓN  
FINA GARANTIZADA

GUARANTEED  
FINA COMPLIANCE

HOMOLOGATION  
FINA GARANTIE



MENOS RECURSOS  
MENOS RESIDUOS

FEWER RESOURCES,  
LESS WASTE

MOINS DE RESSOURCES  
ET MOINS DE DÉCHETS

## SISTEMA 10

Un innovador sistema constructivo que permite construir Piscinas Desbordantes de Hormigón mediante bloques prefabricados en un tiempo récord y con todas las garantías.

## THE 10 SYSTEM

An innovative construction system that allows the construction of concrete overflow pools with prefabricated blocks in record time and with all the guarantees.

## SYSTÈME 10

Un système de construction innovant qui permet de réaliser des piscines à débordement en béton à partir de blocs préfabriqués en un temps record et avec toutes les garanties.

# colors & water colors

Los colores del agua  
son orientativos

Water colors  
are indicative



Les couleurs de l'eau  
sont indicatives

Juntas de colocación  
Fixcer recomendadas

Recommended Fixcer  
Grouting color

Joints d'installation  
Fixcer recommandés

## EUROCOLOR FLEX

-  0 | Blanco
-  8 | Gris claro
-  9 | Gris cemento
-  10 | Antracita
-  46 | Piedra
-  48 | Marrón arena

## CERPOXI / PROFESSIONAL PX

-  0 | Blanco
-  2 | Beige oscuro
-  4 | Marrón claro
-  8 | Gris claro
-  9 | Gris cemento
-  10 | Antracita
-  11 | Negro
-  75 | Chocolate

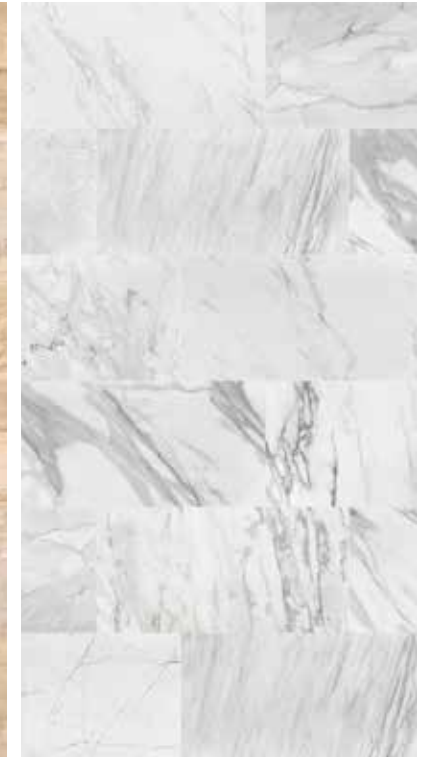

### Mythos Selene

48,8 x 97,9 x 1 Anti-slip  
48,8 x 97,9 x 1 Liso - Rectificado  
31 x 62,6 x 0,9 Anti-slip

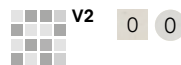

### Mythos Dune

48,8 x 97,9 x 1 Anti-slip  
48,8 x 97,9 x 1 Liso - Rectificado  
31 x 62,6 x 0,9 Anti-slip



### Mythos Antique

48,8 x 97,9 x 1 Anti-slip  
48,8 x 97,9 x 1 Liso - Rectificado  
31 x 62,6 x 0,9 Anti-slip

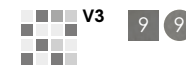

Liso = Smooth = Lisse  
Rectificado = Rectified = Rectification



### Iconic White

48,8 x 97,9 x 1 Anti-slip  
48,8 x 97,9 x 1 Liso - Rectificado  
31 x 62,6 x 0,9 Anti-slip  
31 x 62,6 x 0,9 Pastilla

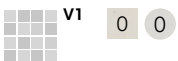

### Iconic Grey

48,8 x 97,9 x 1 Anti-slip  
48,8 x 97,9 x 1 Liso - Rectificado  
31 x 62,6 x 0,9 Anti-slip  
31 x 62,6 x 0,9 Pastilla



### Iconic Dark

48,8 x 97,9 x 1 Anti-slip  
48,8 x 97,9 x 1 Liso - Rectificado  
31 x 62,6 x 0,9 Anti-slip  
31 x 62,6 x 0,9 Pastilla



### Trésor Bali

31 x 62,6 x 0,9 Anti-slip  
31,3 x 31,3 Mosaic Anti-slip



### Trésor Java

31 x 62,6 x 0,9 Anti-slip  
31,3 x 31,3 Mosaic Anti-slip



# colors & water colors

Los colores del agua  
son orientativos

Water colors  
are indicative

Les couleurs de l'eau  
sont indicatives

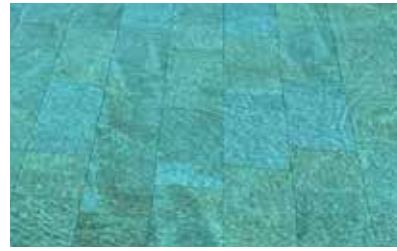

**Pietro White**

48,8 x 97,9 x 1 Anti-slip  
48,8 x 97,9 x 1 Liso - Rectificado  
31 x 62,6 x 0,9 Anti-slip  
31 x 62,6 x 0,9 Pastilla

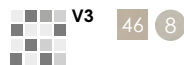

**Pietro Golden**

48,8 x 97,9 x 1 Anti-slip  
48,8 x 97,9 x 1 Liso - Rectificado  
31 x 62,6 x 0,9 Anti-slip  
31 x 62,6 x 0,9 Pastilla



**Pietro Grey**

48,8 x 97,9 x 1 Anti-slip  
31 x 62,6 x 0,9 Anti-slip  
31 x 62,6 x 0,9 Pastilla



**Pietro Dark**

48,8 x 97,9 x 1 Anti-slip  
31 x 62,6 x 0,9 Anti-slip  
31 x 62,6 x 0,9 Pastilla



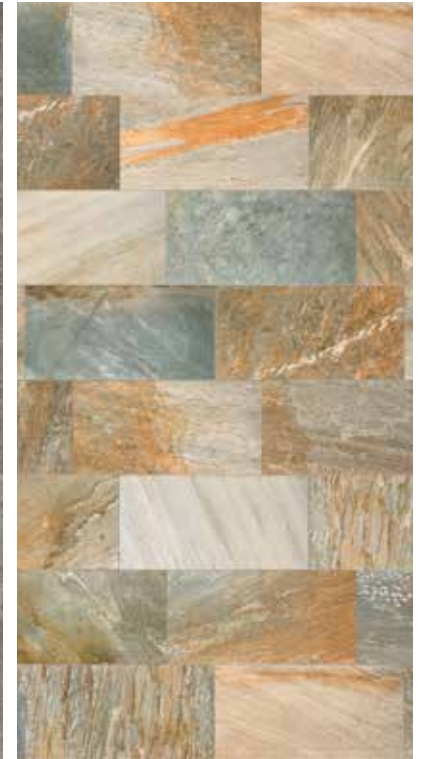

**Serena Bianco**

48,8 x 97,9 x 1 Anti-slip  
48,8 x 97,9 x 1 Liso - Rectificado  
31 x 62,6 x 0,9 Anti-slip

**Serena Ocra**

48,8 x 97,9 x 1 Anti-slip  
48,8 x 97,9 x 1 Liso - Rectificado  
31 x 62,6 x 0,9 Anti-slip

**Serena Griggio**

31 x 62,6 x 0,9 Anti-slip

**Serena Nero**

31 x 62,6 x 0,9 Anti-slip

**Serena Mix**

31 x 62,6 x 0,9 Anti-slip

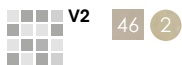
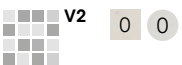

# colors & water colors

Los colores del agua  
son orientativos

Water colors  
are indicative

Les couleurs de l'eau  
sont indicatives



## Mystery White

48,8 x 97,9 x 1 Anti-slip  
48,8 x 97,9 x 1 Liso - Rectificado  
31 x 62,6 x 0,9 Anti-slip  
31 x 62,6 x 0,9 Liso  
31,3 x 31,3 Mosaic Liso



## Mystery Sand

48,8 x 97,9 x 1 Anti-slip  
48,8 x 97,9 x 1 Liso - Rectificado  
31 x 62,6 x 0,9 Anti-slip  
31 x 62,6 x 0,9 Liso  
31,3 x 31,3 Mosaic Liso



## Mystery Grey

48,8 x 97,9 x 1 Anti-slip  
48,8 x 97,9 x 1 Liso - Rectificado  
31 x 62,6 x 0,9 Anti-slip  
31 x 62,6 x 0,9 Liso  
31,3 x 31,3 Mosaic Liso



## Mystery Blue Stone

48,8 x 97,9 x 1 Anti-slip  
48,8 x 97,9 x 1 Liso - Rectificado  
31 x 62,6 x 0,9 Anti-slip  
31 x 62,6 x 0,9 Liso  
31,3 x 31,3 Mosaic Liso



Liso = Smooth = Lisse

Rectificado = Rectified = Rectification

Mosaico Emallado = Mesh-mounted Mosaic = Mosaïque Émaux



# Wood texture



**Stela White**

19,4 x 97,9 x 1 Anti-slip  
19,4 x 97,9 x 1 Liso

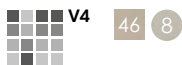

**Stela Golden**

19,4 x 97,9 x 1 Anti-slip  
19,4 x 97,9 x 1 Liso

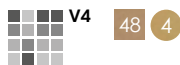

**Stela Grey**

19,4 x 97,9 x 1 Anti-slip  
19,4 x 97,9 x 1 Liso



**Stela Dark**

19,4 x 97,9 x 1 Anti-slip  
19,4 x 97,9 x 1 Liso





# wo od tex tu re



## Alma Pure

19,4 x 97,9 x 1 Anti-slip  
19,4 x 97,9 x 1 Liso

## Alma Honey

19,4 x 97,9 x 1 Anti-slip  
19,4 x 97,9 x 1 Liso

## Alma Forest

19,4 x 97,9 x 1 Anti-slip  
19,4 x 97,9 x 1 Liso

## Alma Mist

19,4 x 97,9 x 1 Anti-slip  
19,4 x 97,9 x 1 Liso



# constructive systems



**Sistema desbordante**  
Deck level pool system  
Système à débordement

**Prestige**



**Sistema desbordante**  
Deck level pool system  
Système à débordement

**Slim**



**Sistema desbordante**  
Deck level pool system  
Système à débordement

**Smart**



**Sistema desbordante**  
Deck level pool system  
Système à débordement

**Zen**

# constructive systems



**Solución Piscina Infinity**  
Infinity Pool Solution  
Solution Piscine Infinity



**Sistema Skimmer, solución «L»**  
Skimmer System, «L» solution  
Système Skimmer, solution «L»



**Sistema Skimmer, solución «S»**  
Skimmer System, «S» solution  
Système Skimmer, solution «S»



**New Look System**  
New Look System  
New Look System

# Prestige

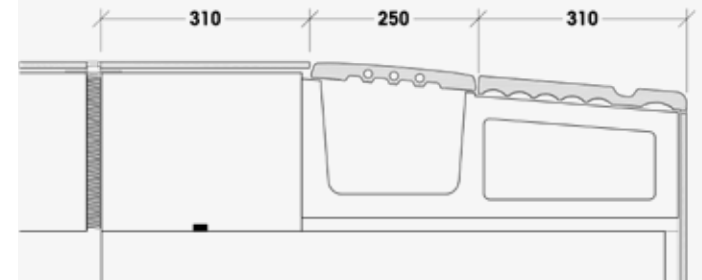
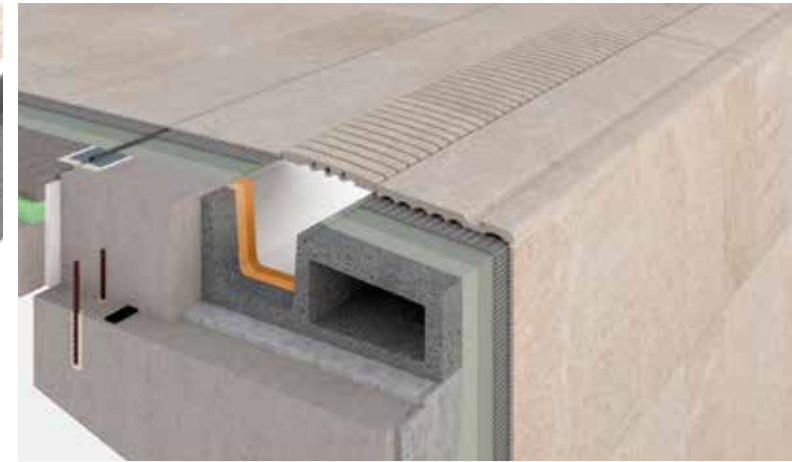
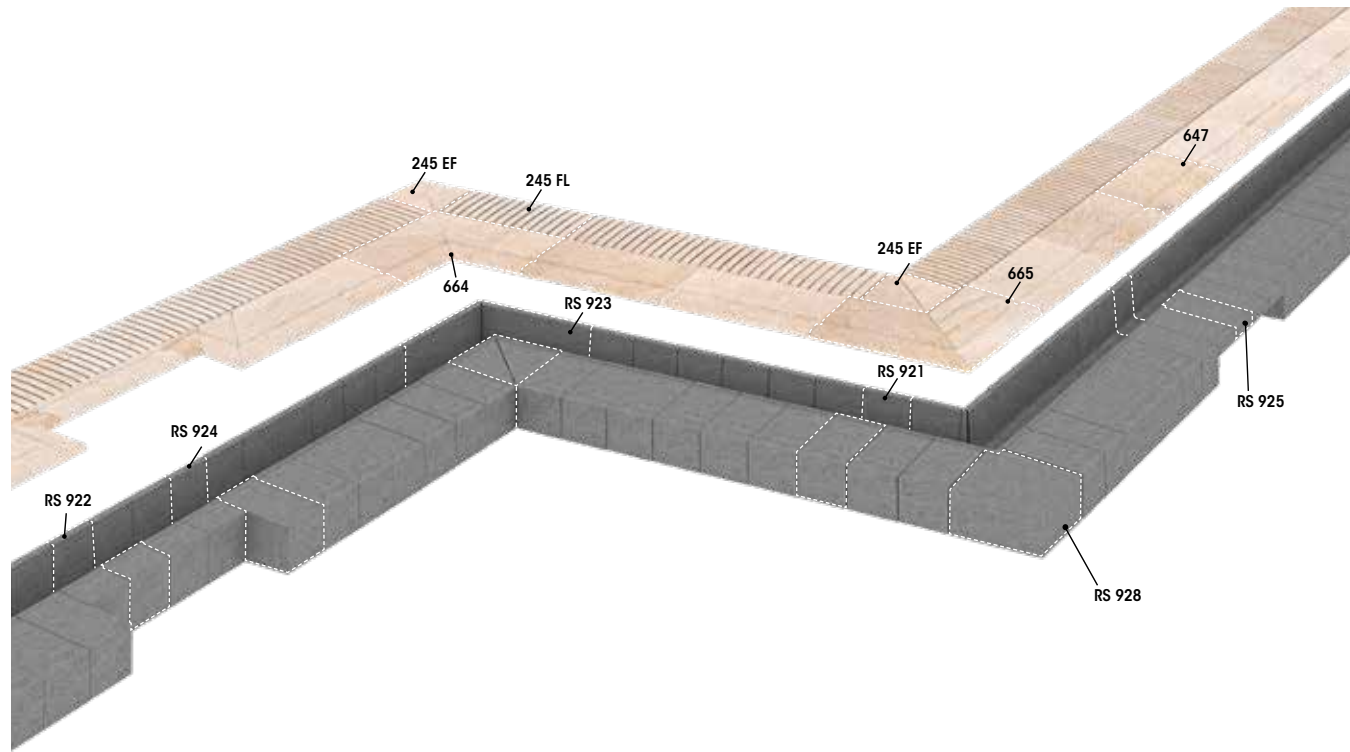

## Bloques S9 | S9 Blocks | Modules S9

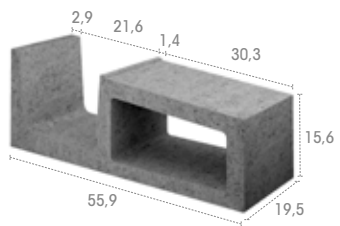

**RS 921**

Base

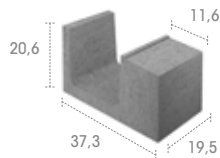

**RS 922**

Escalera abierta  
Open built-in stairs  
Échelle ouverte

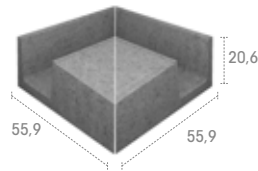

**RS 923**

Esquina interior  
Inside corner  
Angle intérieur

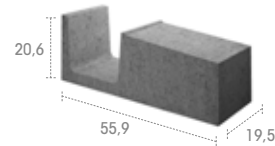

**RS 924**

Maciza  
Solid  
Solide

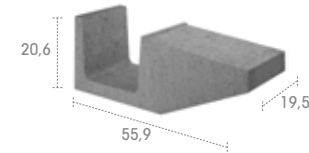

**RS 925**

Escalera cerrada  
Closed built-in stairs  
Échelle fermée

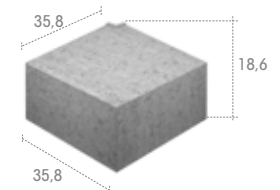

**RS 928**

Esquina exterior  
Outside corner  
Angle extérieur

Sistema de pre-playa descendente solucionado con la ref. 647 de 31 x 62,7 cm. Los bloques S9 generan la pendiente y funcionan como punto de apoyo para la rejilla del rebosadero.

Downward sloping pre-deck system using ref. 647 measuring 31 x 62.7 cm. S9 blocks provide the slope and support the overflow grate.

Système de débordement avant plage avec pente vers bassin avec la réf. 647 de 31 x 62,7 cm. Les blocs S9 génèrent la pente et servent de point d'appui à la grille de débordement.

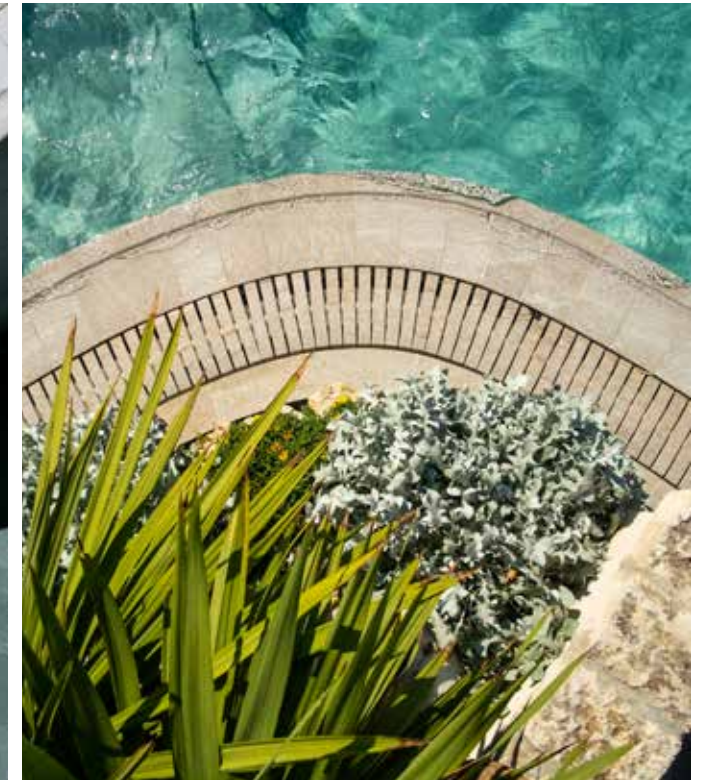
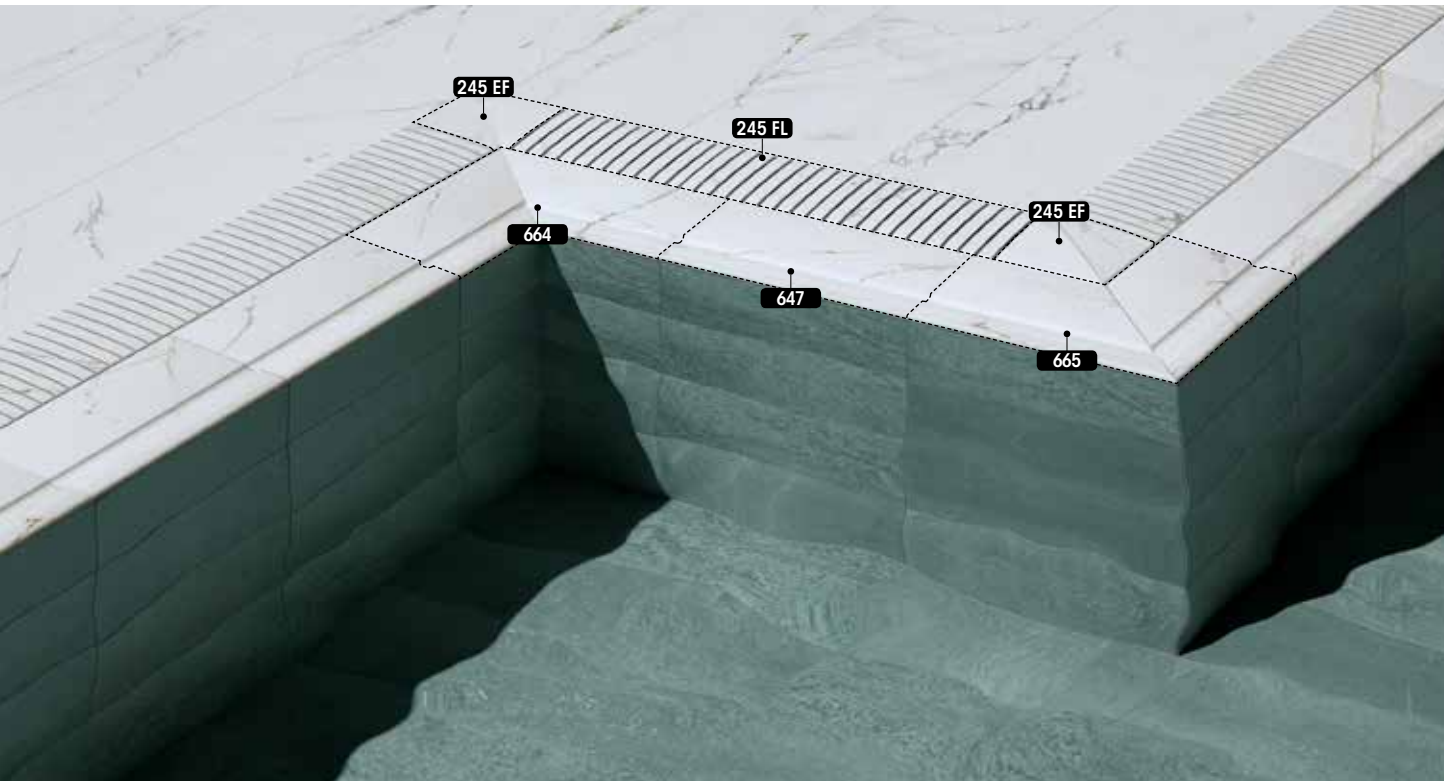

Piezas de borde | Edge tiles | Margelles  Maciza/Solid/Solide

Rejilla Flex | Flex Grid | Grille Flex

**647 Anti-Slip**  
62,6 x 31 x 2,6



**664 Anti-Slip**  
62,6 x 62,6 x 2,6

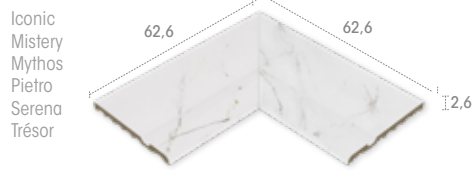

**665 Anti-Slip**  
62,6 x 62,6 x 2,6

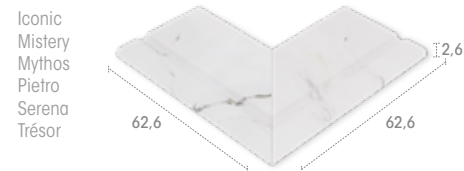

**245 FL Anti-Slip**  
49,5 x 24,5 x 2,2

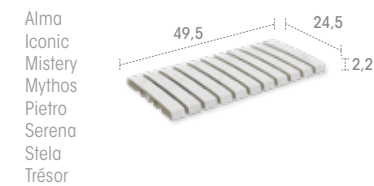

**245 EF Anti-Slip**  
26,6 x 26,6 x 2,2

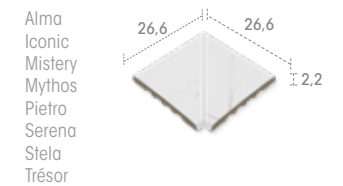

# Slim

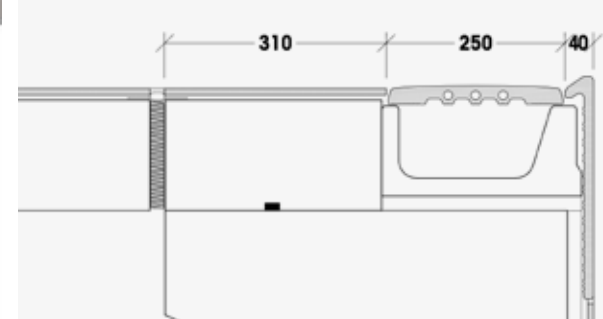
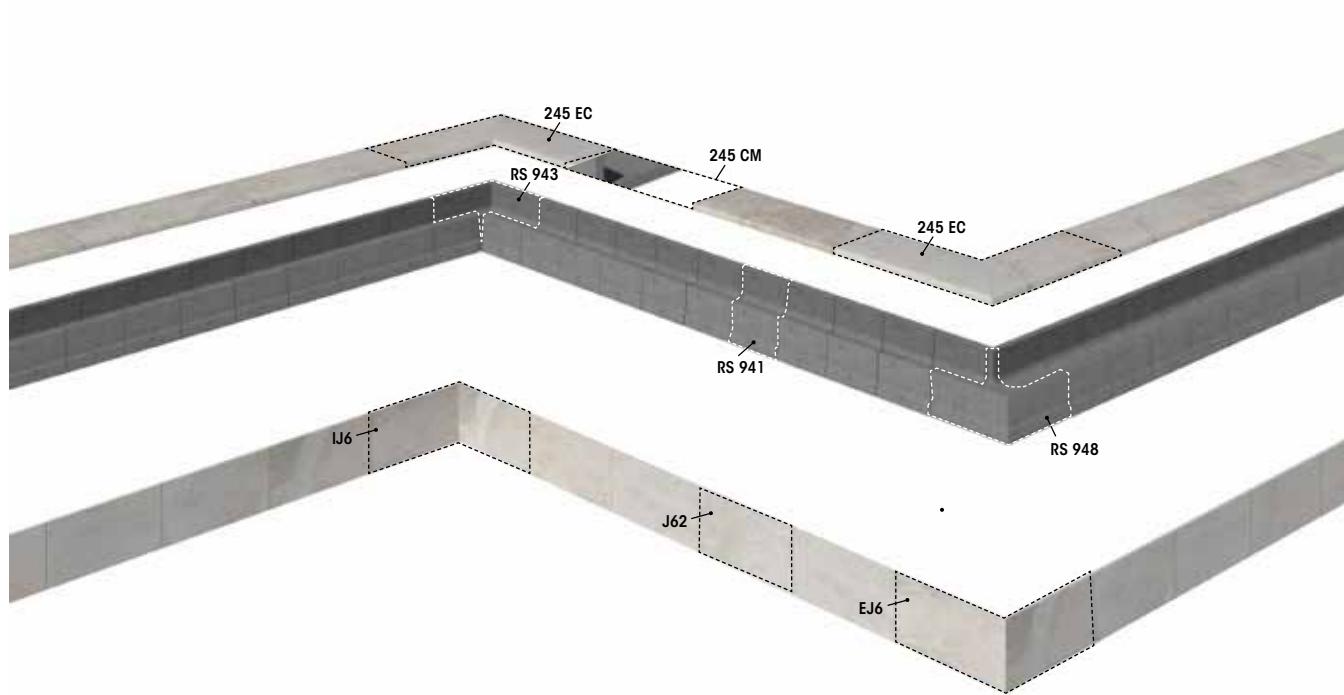

Bloques S9 | S9 Blocks | Modules S9

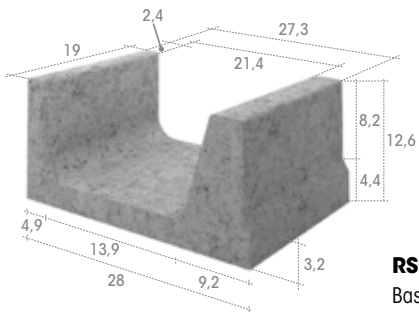

**RS 941**  
Base

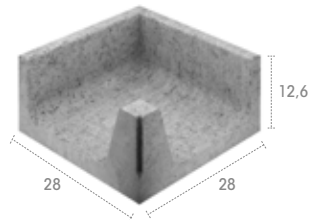

**RS 943**  
Esquina interior  
Inside corner  
Angle intérieur

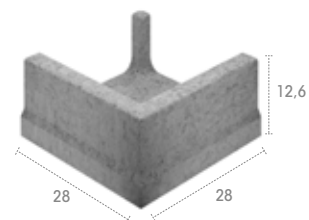

**RS 948**  
Esquina exterior  
Outside corner  
Angle extérieur

La innovación del Sistema Slim soluciona los proyectos de piscinas desbordantes con playas estrechas de forma práctica y funcional. Su diseño sitúa el nivel del agua por encima del nivel de la playa. Consigue recrear un bonito efecto espejo.

The innovative Slim System is a practical and functional solution for overflow pool projects with limited deck space. The design places the water level above the deck, creating an attractive mirror effect.

L'innovation du Système Slim apporte une solution pratique et fonctionnelle aux projets de piscine à débordement avec un espace de plage réduit. Sa conception situe le niveau de l'eau au-dessus du niveau de la plage et permet de créer un très joli effet miroir.

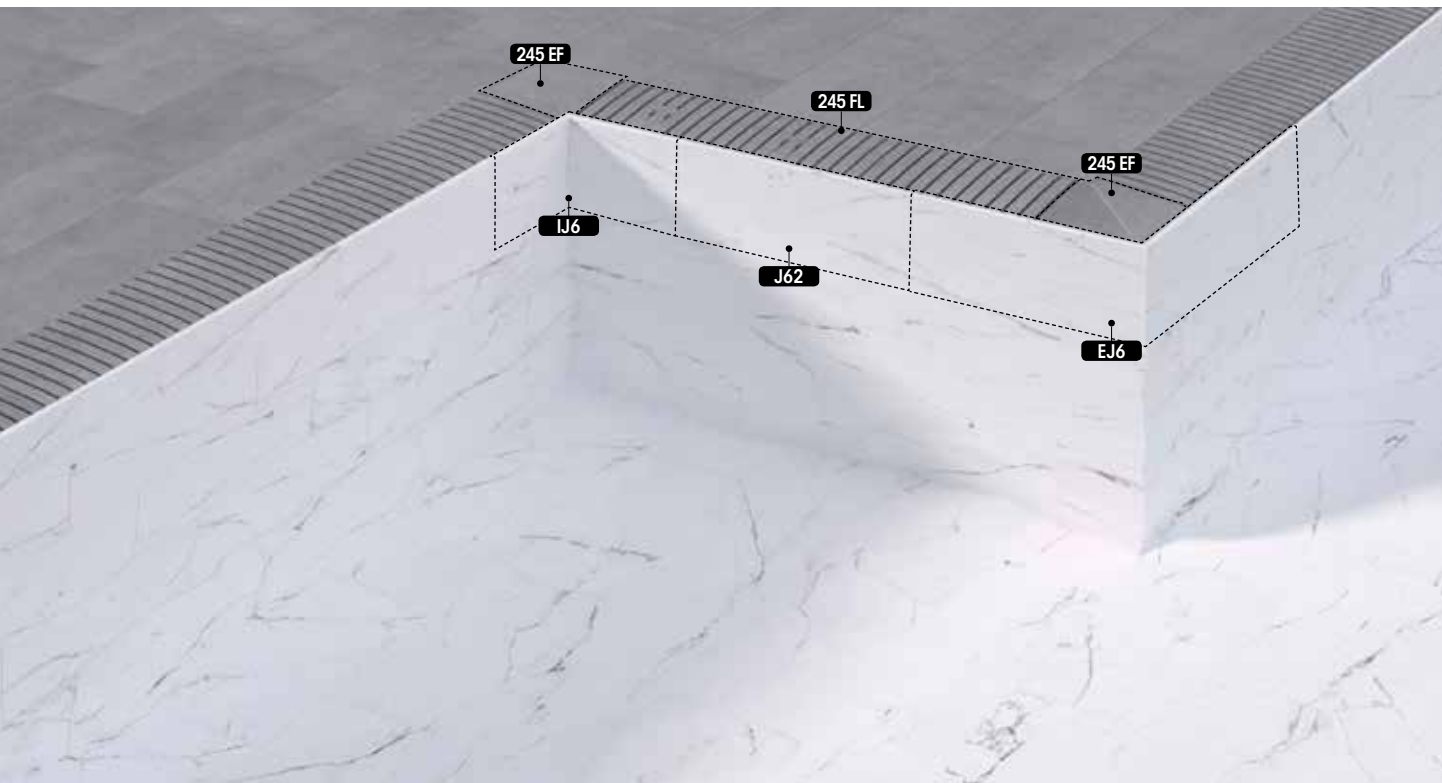

Piezas de borde | Edge tiles | Margelles  Maciza/Solid/Solide

Rejilla Flex | Flex Grid | Grille Flex

**J62 Anti-Slip**  
62,6 x 31 x 3,8

Iconic  
Mistery  
Mythos  
Pietro  
Serena  
Trésor

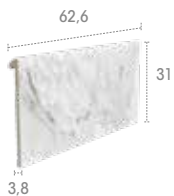

**IJ6 Anti-Slip**  
31 x 31 x 31

Iconic  
Mistery  
Mythos  
Pietro  
Serena  
Trésor

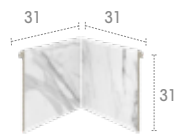

**EJ6 Anti-Slip**  
62,6 x 62,6 x 31

Iconic  
Mistery  
Mythos  
Pietro  
Serena  
Trésor

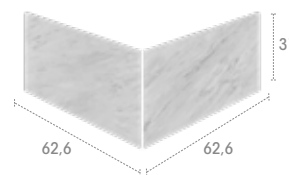

**245 FL Anti-Slip**  
49,5 x 24,5 x 2,2

Alma  
Iconic  
Mistery  
Mythos  
Pietro  
Serena  
Stela  
Trésor

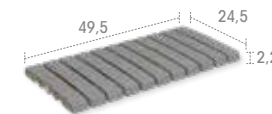

**245 EF Anti-Slip**  
26,6 x 26,6 x 2,2

Alma  
Iconic  
Mistery  
Mythos  
Pietro  
Serena  
Stela  
Trésor

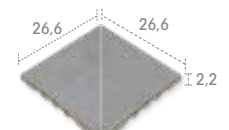

# Smart

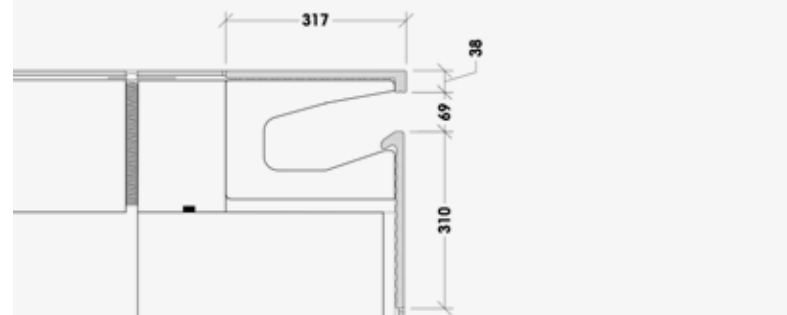
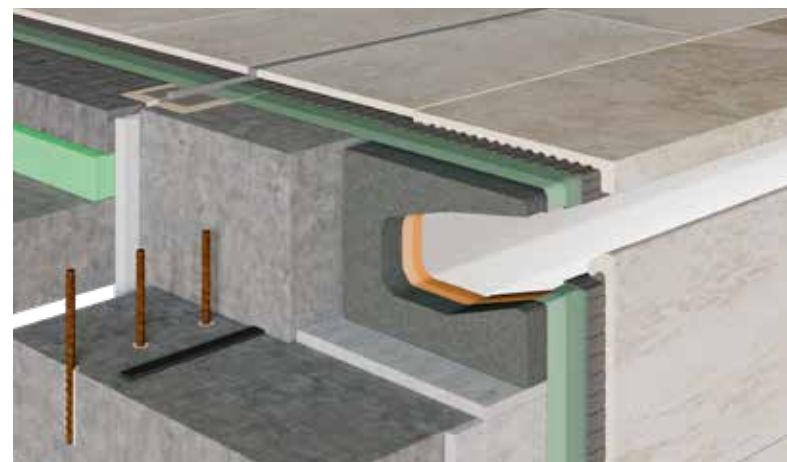
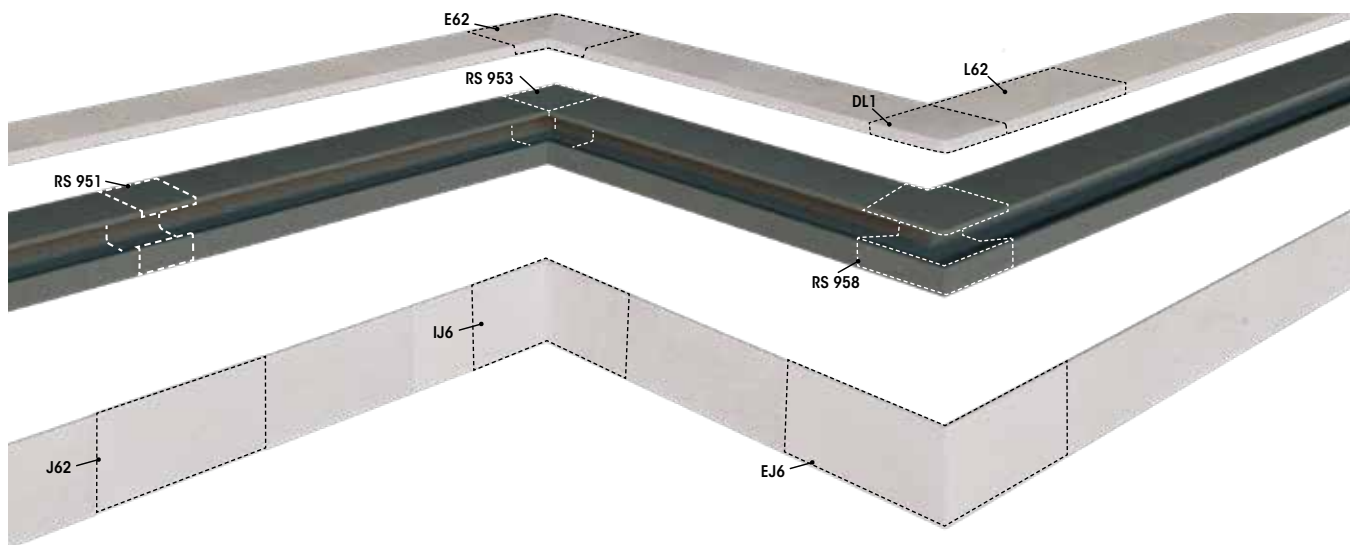

Bloques S9 | S9 Blocks | Modules S9

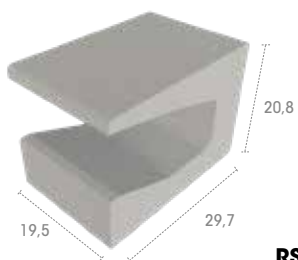

**RS 951**  
Base

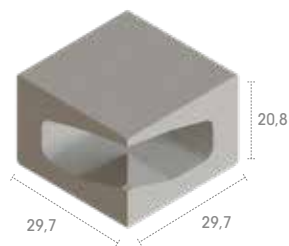

**RS 953**  
Esquina interior  
Inside corner  
Angle intérieur

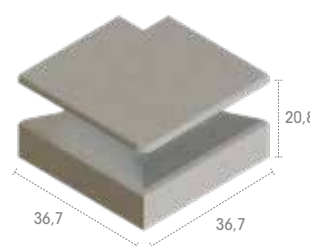

**RS 958**  
Esquina exterior  
Outside corner  
Angle extérieur



Sistema desbordante longitudinal oculto. Su innovación hace posible que el nivel del agua se sitúe por debajo del nivel de la playa. De esta forma se evita que el agua salga de la piscina. Su diseño ofrece un buen agarre del bañista.

Hidden longitudinal overflow system that allows the water level to remain below deck level. This prevents water from spilling out of the pool. The design also provides a handhold for swimmers.

Il s'agit d'un système à débordement longitudinal invisible. Il permet de maintenir le niveau de l'eau en-dessous de la plage. Il empêche ainsi l'eau de déborder hors de la piscine. Il est conçu de telle façon que les nageurs peuvent s'y agripper commodément.



Piezas de borde | Edge tiles | Margelles  Maciza/Solid/Solide

**J62 Anti-Slip**  
62,6 x 31 x 3,8

Iconic  
Mistery  
Mythos  
Pietro  
Serena  
Trésor

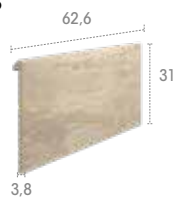

**IJ6 Anti-Slip**  
31 x 31 x 31

Iconic  
Mistery  
Mythos  
Pietro  
Serena  
Trésor

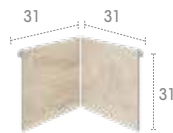

**EJ6 Anti-Slip**  
62,6 x 62,6 x 31

Iconic  
Mistery  
Mythos  
Pietro  
Serena  
Trésor

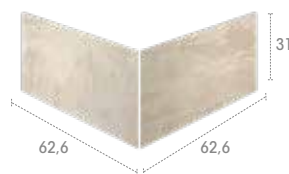

# Zen

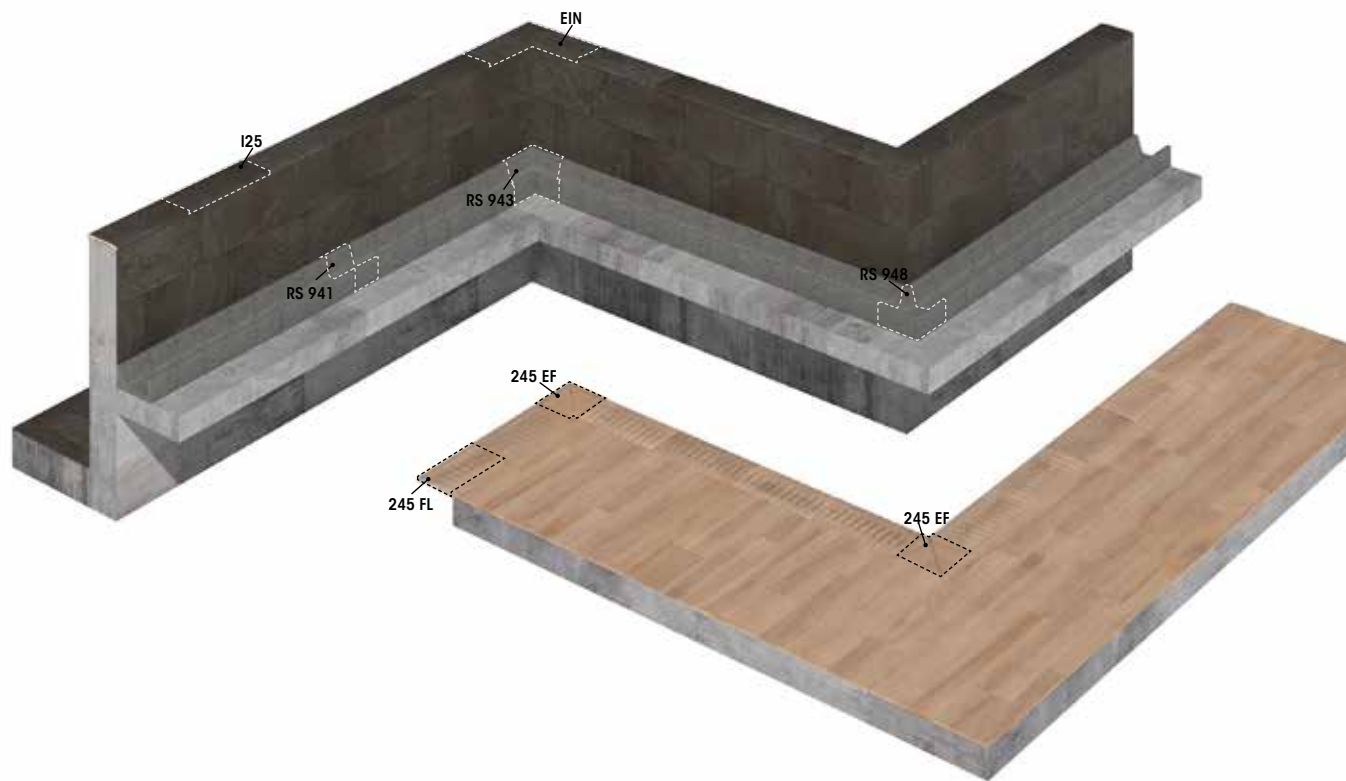

Bloques S9 | S9 Blocks | Modules S9

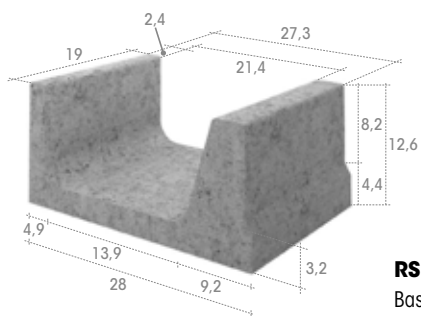

**RS 941**  
Base

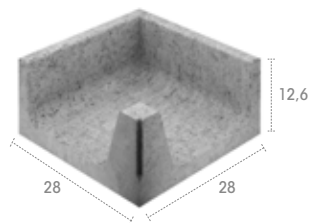

**RS 943**  
Esquina interior  
Inside corner  
Angle intérieur

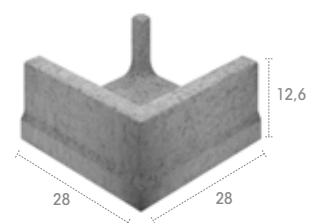

**RS 948**  
Esquina exterior  
Outside corner  
Angle extérieur

Piscina con desborde perimetral elevado sobre un canal oculto empotrado en la playa. El Sistema Zen es perfecto para construir una original piscina de inspiración balinesa.

Pool with raised perimeter overflow above a hidden channel integrated into the deck. The Zen System is perfect for building an original Balinese-inspired pool.

Piscine à débordement périmétrique surélevé au-dessus d'un canal invisible intégré dans la plage. Le Système Zen est parfait pour construire une piscine originale d'inspiration balinaise.



Piezas de borde | Edge tiles | Margelles

**I25 Anti-Slip**

62,6 x 24,5 x 2,2

- Alma
- Iconic
- Mistery
- Mythos
- Pietro
- Serena
- Stela
- Trésor

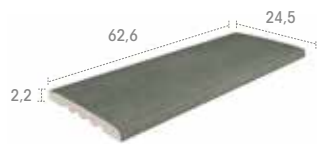

**EIN Anti-Slip**

62,6 x 62,6 x 2,2

- Alma
- Iconic
- Mistery
- Mythos
- Pietro
- Serena
- Stela
- Trésor

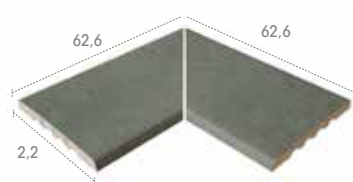

# Flex



Su estructura en forma de trapecio evita el puente de agua incluso cuando está mal colocada. Facilita la reposición de piezas sueltas. Permite realizar curvas a partir de un radio de 75 cm.

Trapezoidal structure allows for perfect water flow even when poorly laid. Loose pieces can be easily repositioned. It can be used to create curves with a radius of more than 75 cm.

Sa structure trapézoïdale permet une parfaite évacuation de l'eau. La mise en place de pièces de remplacement est simplifiée. Permet de réaliser des courbes à partir d'un rayon de 75 cm.



Piezas | Pieces | Pièces

## 245 FL Anti-Slip

49,5 x 24,5 x 2,2

Alma  
Iconic  
Mistery  
Mythos  
Pietro  
Serena  
Stela  
Trésor



## 245 EF Anti-Slip

26,6 x 26,6 x 2,2

Alma  
Iconic  
Mistery  
Mythos  
Pietro  
Serena  
Stela  
Trésor



# Compact



Consiste en una sola pieza fabricada sin adhesivos. Al colocarla queda totalmente integrada con el borde. El desagüe se realiza a través de un sistema de orificios laterales apenas visible y con una capacidad óptima.

Composed of a single piece, without adhesives. Once in place, it blends in perfectly with the edge of the pool. The water is drained through side openings that are barely visible and have optimal capacity.

Elle consiste en une seule pièce, conçue sans adhésifs. Sa mise en place l'intègre totalement au débordement. Le drainage s'effectue à travers les mini canaux latéraux, à peine visibles mais d'une capacité optimale.

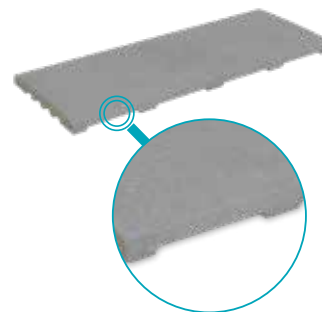

Piezas | Pieces | Pièces

## 245 CM Anti-Slip

62,6 x 24,5 x 2,2

Alma  
Iconic  
Mistery  
Mythos  
Pietro  
Serena  
Stela  
Trésor



## 245 EC Anti-Slip

62,6 x 62,6 x 2,2

Alma  
Iconic  
Mistery  
Mythos  
Pietro  
Serena  
Stela  
Trésor

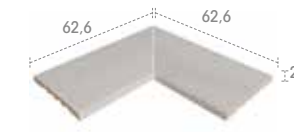



Una solución única para construir piscinas Infinity. Se trata de una pieza especial multifunción. La misma pieza sirve para revestir el murete de la piscina y el murete del canal de recogida del agua. Así conseguimos un precioso diseño integrado.

Unique solution for the construction of infinity pools. This is a special multi-purpose piece. The same piece is used to line the walls of the pool and the wall of the water collection channel. This way the edge, pool and walls all match beautifully.

Une solution unique pour la construction de piscines à débordement. Il s'agit d'une pièce spéciale multifonctionnelle. La même pièce peut être utilisée pour couvrir la paroi de la piscine et la paroi du canal de collecte de l'eau. Cela permet de créer un magnifique design intégré.



Piezas | Pieces | Pièces

### I25 Anti-Slip

62,6 x 24,5 x 2,2

Alma  
Iconic  
Mistery  
Mythos  
Pietro  
Serena  
Stela  
Trésor

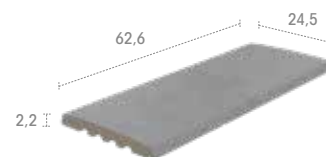

### EIN Anti-Slip

62,6 x 62,6 x 2,2

Alma  
Iconic  
Mistery  
Mythos  
Pietro  
Serena  
Stela  
Trésor

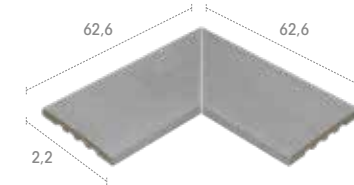

# L SOLUTION



# S SOLUTION

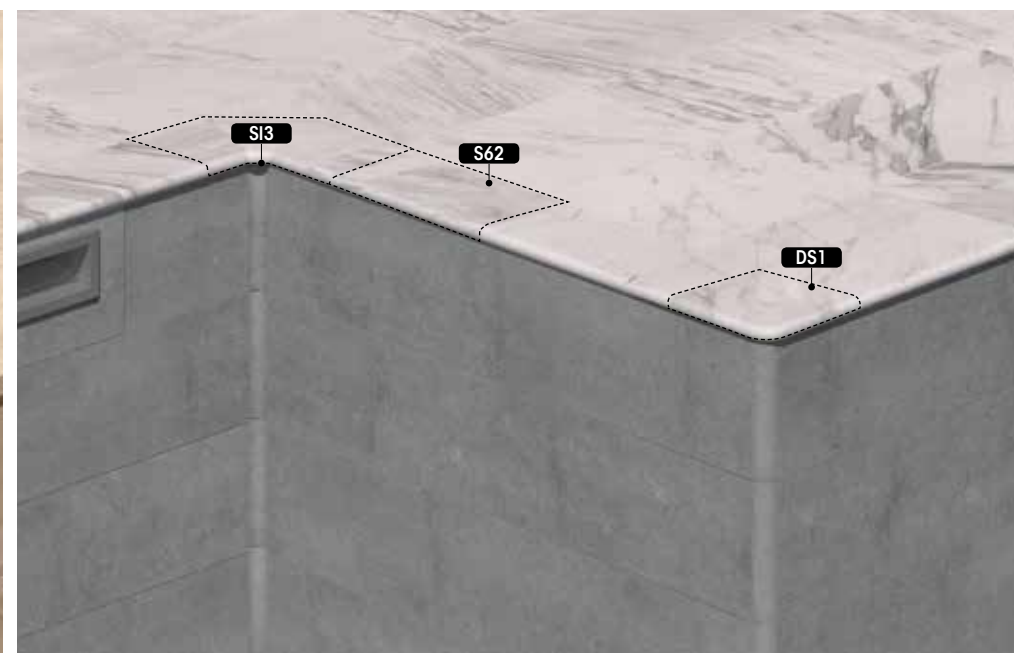

### L62 Anti-Slip

62,6 x 31,7 x 3,8

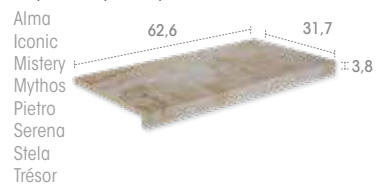

### L98 Anti-Slip

97,9 x 31,7 x 3,8



### E62 Anti-Slip

62,6 x 62,6 x 3,8

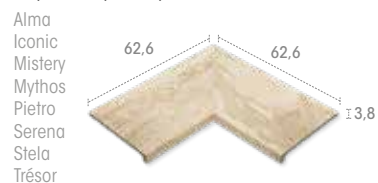

### DL1 Anti-Slip

31,7 x 31,7 x 3,8

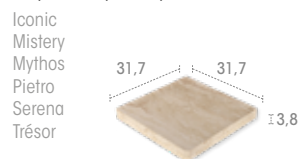

### DL2 Anti-Slip

31,7 x 31,7 x 3,8

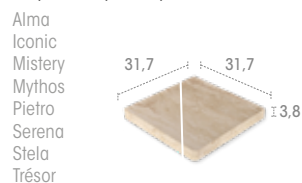

### S62 Anti-Slip

62,6 x 31 x 2,6

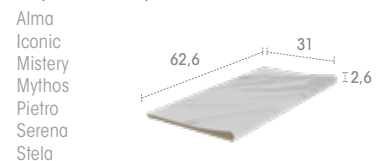

### SI3 Anti-Slip

46 x 46 x 2,6

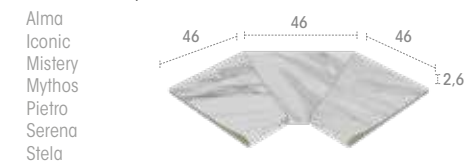

### SE3 Anti-Slip

31 x 31 x 2,6



### DS1 Anti-Slip

31 x 31 x 2,6



# new look system

## SOLUCIÓN REHABILITACIÓN PISCINAS

El nuevo sistema para rehabilitar piscinas antiguas con gres porcelánico de alta calidad.

## POOL RENOVATION SOLUTION

A new system for renovating the old pools with high-quality porcelain stoneware.

## SOLUTION RÉNOVATION PISCINES

Le nouveau système pour rénover les anciennes piscines avec du grès cérame de haute qualité.

### Piezas esmaltadas a 3 caras.

**Dos formatos de borde con un ancho de 50 cm.** La dimensión perfecta para lograr una sustitución sencilla y eficaz en la mayoría de piscinas antiguas.

### Pieces glazed on 3 sides.

**Two edge formats with a width of 50 cm.** The perfect size for simple and effective replacement in most old pools.

### Pièces émaillées sur 3 faces.

**Deux formats de bordure de 50 cm de large.** La dimension parfaite pour un remplacement simple et efficace pour la plupart des piscines anciennes.



Antes / Before / Avant



Después / After / Après



Piezas de borde y acabados en curva | Edging tiles and curved finishes | Margelles et finitions incurvées

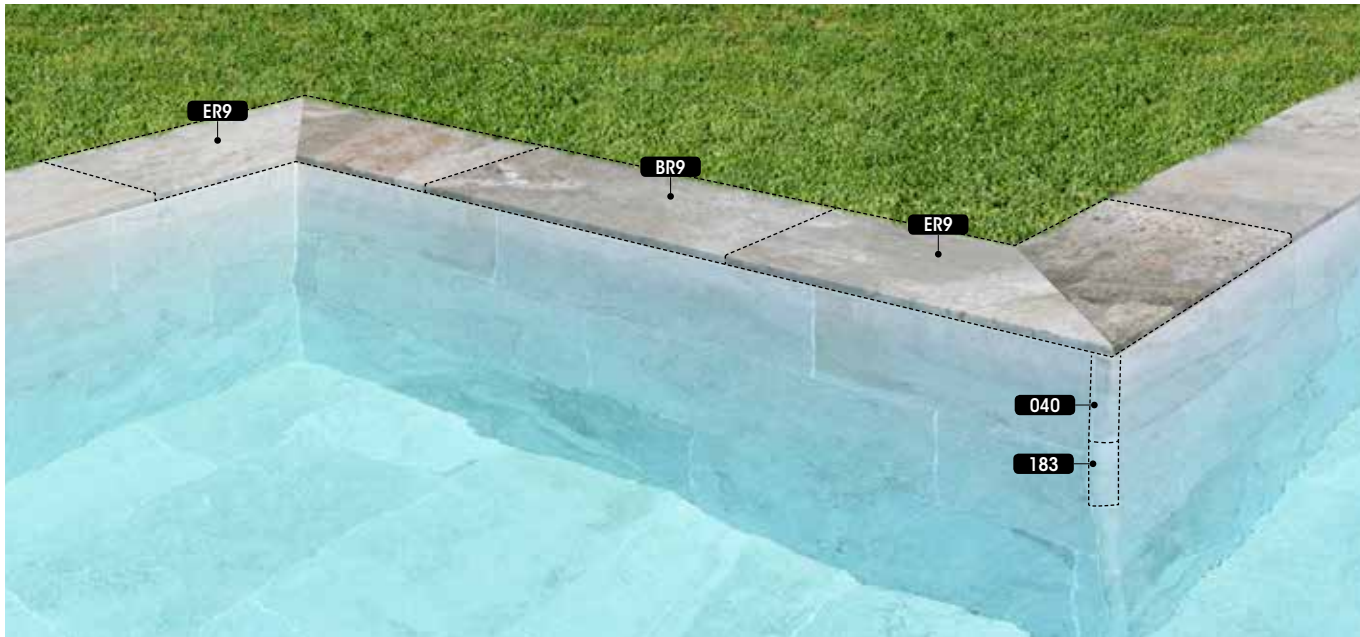

**BR6 Anti-Slip**  
62,6 x 50 x 2,6

- Iconic White
- Mystery White
- Mystery Grey
- Mystery Blue stone
- Mythos Dune
- Pietro White
- Pietro Golden
- Pietro Grey
- Pietro Dark
- Serena Ocra

**ER6 Anti-Slip**  
62,6 x 62,6 x 50 x 2,6

- Iconic White
- Mystery White
- Mystery Grey
- Mystery Blue stone
- Mythos Dune
- Pietro White
- Pietro Golden
- Pietro Grey
- Pietro Dark
- Serena Ocra

**BR9 Anti-Slip**  
97,9 x 50 x 2,6

- Iconic White
- Mystery White
- Mystery Grey
- Mystery Blue stone
- Mythos Dune
- Pietro White
- Pietro Golden
- Pietro Grey
- Pietro Dark
- Alma Forest

**ER9 Anti-Slip**  
97,9 x 97,9 x 50 x 2,6

- Iconic White
- Mystery White
- Mystery Grey
- Mystery Blue stone
- Mythos Dune
- Pietro White
- Pietro Golden
- Pietro Grey
- Pietro Dark
- Alma Forest



**056**  
62,6 x 5 x 0,9

- Iconic
- Mystery
- Mythos
- Pietro
- Serena
- Trésor

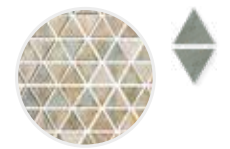

**E56**  
5 x 4,3 x 0,9

- Iconic
- Mystery
- Mythos
- Pietro
- Serena
- Trésor

- Material suministrado sin enmallar
- Material supplied unmeshed
- Matériau fourni non maillé

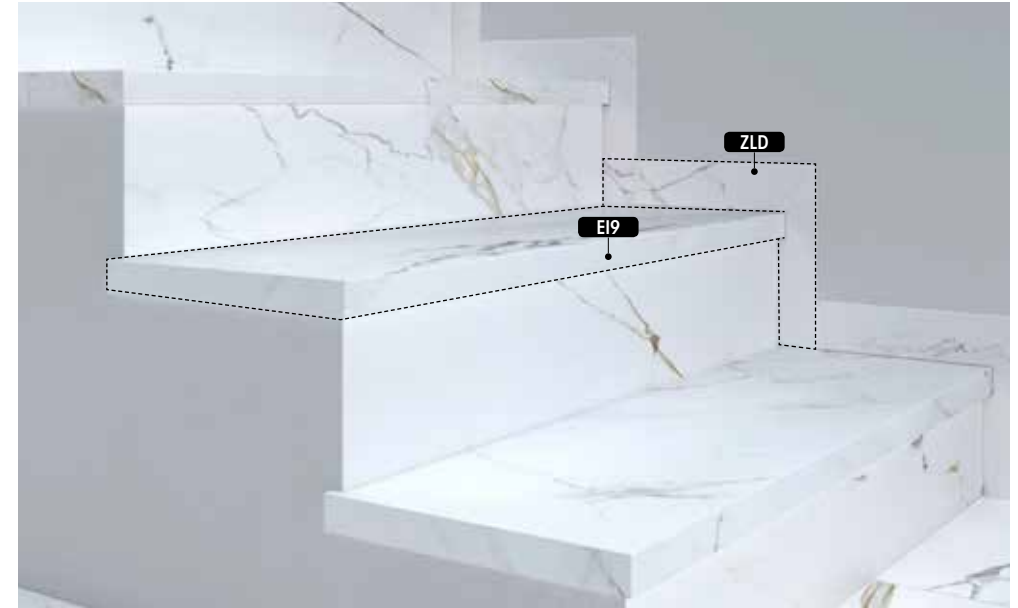
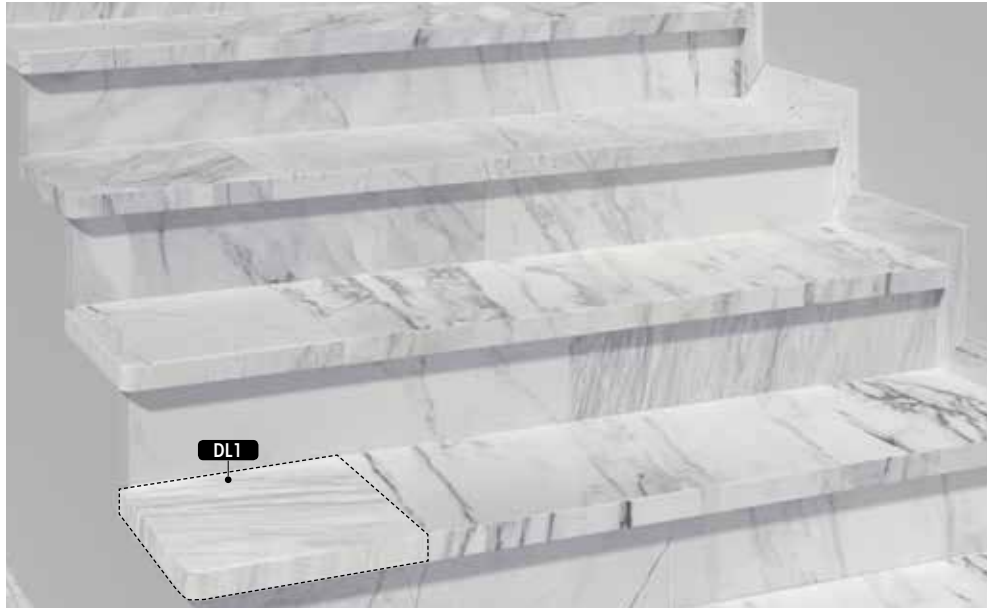

**L98 Anti-Slip**

97,9 x 31,7 x 3,8

Alma  
Iconic  
Mistery  
Mythos  
Pietro  
Stela

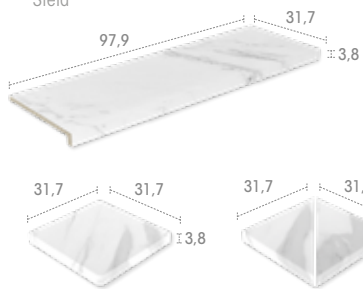

**New** **L98 Liso**

97,9 x 31,7 x 3,8

Mythos Selene Pietro White  
Mythos Dune Pietro Golden  
Iconic White Serena Bianco  
Iconic Grey Serena Ocro  
Alma Mist Mistery White  
Alma Pure Mistery Grey  
Alma Forest Mistery Sand

**L62 Anti-Slip**

62,6 x 31,7 x 3,8

Alma  
Iconic  
Mistery  
Mythos  
Serena  
Stela  
Trésor

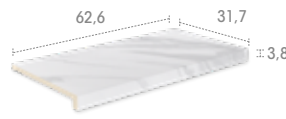

**E19 Anti-Slip**

97,9 x 31,7 x 3,8

Alma  
Iconic  
Mistery  
Mythos  
Pietro  
Stela

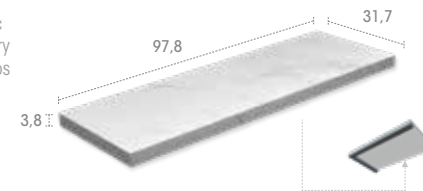

**New** **E19 Liso**

97,9 x 31,7 x 3,8

Mythos Selene Pietro White  
Mythos Dune Pietro Golden  
Iconic White Serena Bianco  
Iconic Grey Serena Ocro  
Alma Mist Mistery White  
Alma Pure Mistery Grey  
Alma Forest Mistery Sand

**ED9 Anti-Slip**

97,9 x 31,7 x 3,8

Alma  
Iconic  
Mistery  
Mythos  
Pietro  
Stela

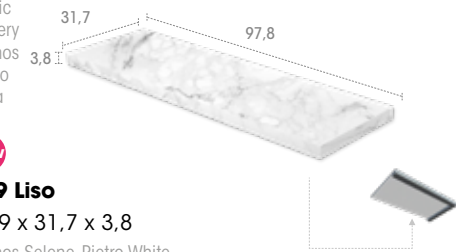

**New** **ED9 Liso**

97,9 x 31,7 x 3,8

Mythos Selene Pietro White  
Mythos Dune Pietro Golden  
Iconic White Serena Bianco  
Iconic Grey Serena Ocro  
Alma Mist Mistery White  
Alma Pure Mistery Grey  
Alma Forest Mistery Sand

**DL1 Anti-Slip**

31,7 x 31,7 x 3,8

Iconic  
Mistery  
Mythos  
Pietro  
Serena  
Trésor

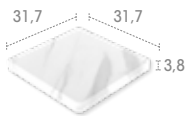

**DL2 Anti-Slip**

31,7 x 31,7 x 3,8

Alma  
Iconic  
Mistery  
Mythos  
Pietro  
Serena  
Stela  
Trésor

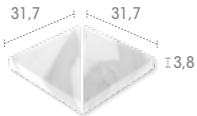

**Z62**

62,6 x 7

Alma  
Iconic  
Mistery  
Mythos  
Pietro  
Serena  
Stela  
Trésor

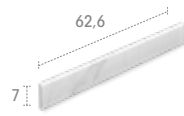

**ZLI**

36,5 x 30 x 7

Alma  
Iconic  
Mistery  
Mythos  
Pietro  
Serena  
Stela  
Trésor

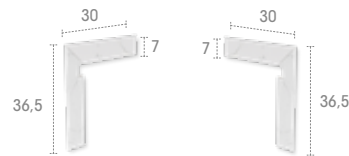

**ZLD**

36,5 x 30 x 7

Alma  
Iconic  
Mistery  
Mythos  
Pietro  
Serena  
Stela  
Trésor

**E16 Anti-Slip**

62,6 x 31,7 x 3,8

Alma  
Iconic  
Mistery  
Mythos  
Pietro  
Serena  
Stela  
Trésor

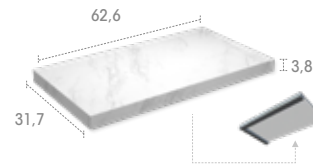

**ED6 Anti-Slip**

62,6 x 31,7 x 3,8

Alma  
Iconic  
Mistery  
Mythos  
Pietro  
Serena  
Stela  
Trésor

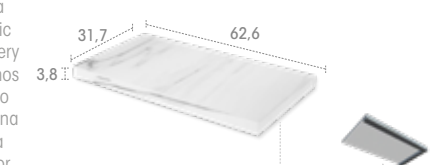

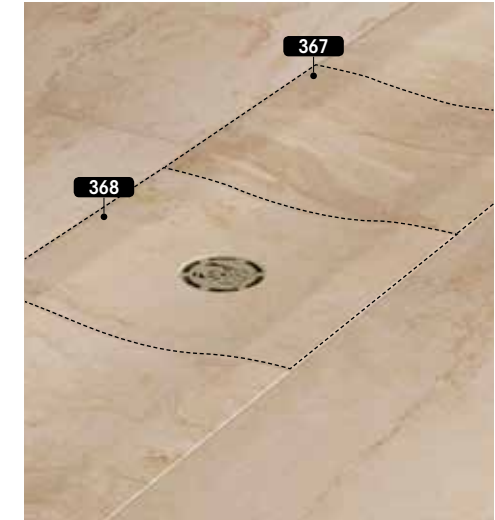
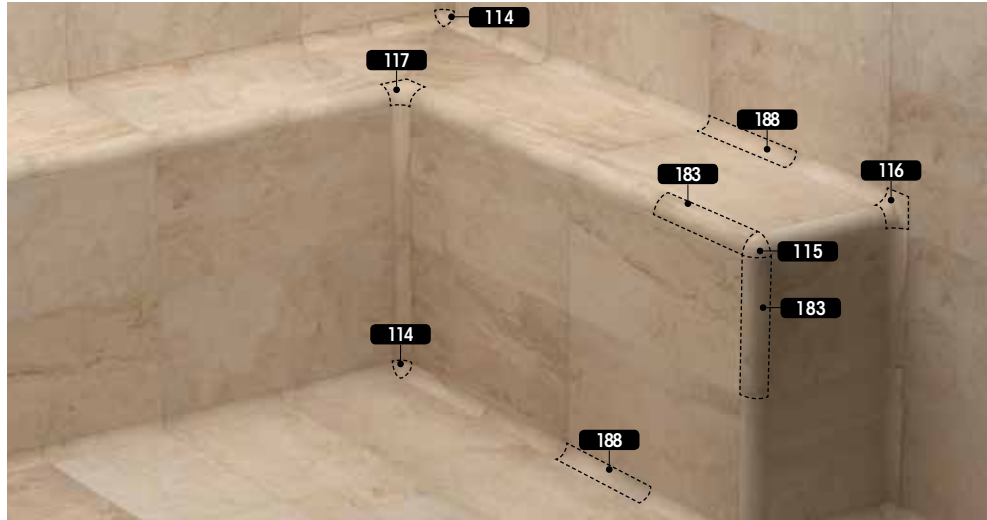

**188 Anti-Slip**

31 x 4 x 4

Iconic  
Mistery  
Mythos  
Pietro  
Serena  
Trésor

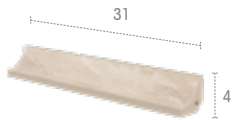

**183 Anti-Slip**

31 x 4 x 4

Iconic  
Mistery  
Mythos  
Pietro  
Serena  
Trésor



**147 Anti-Slip**

31 x 4 x 4

Iconic  
Mistery  
Mythos  
Pietro  
Serena  
Trésor



**121 CM Anti-Slip**

62,6 x 12,5 x 2,2

Alma  
Iconic  
Mistery  
Mythos  
Pietro  
Serena  
Stela  
Trésor

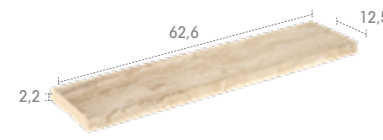

**367 Anti-Slip**

31 x 31 x 2,4

Alma  
Iconic  
Mistery  
Mythos  
Pietro  
Serena  
Stela  
Trésor

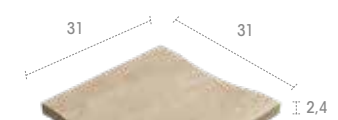

**114 Anti-Slip**

4 x 4

Iconic  
Mistery  
Mythos  
Pietro  
Serena  
Trésor



**115 Anti-Slip**

4 x 4

Iconic  
Mistery  
Mythos  
Pietro  
Serena  
Trésor



**116 Anti-Slip**

4 x 4

Iconic  
Mistery  
Mythos  
Pietro  
Serena  
Trésor



**117 Anti-Slip**

4 x 4

Iconic  
Mistery  
Mythos  
Pietro  
Serena  
Trésor



**CRA C1**

50 x 13 x 7,5



**DCR C1**



**CCR C1**



**TCR C1**



**368 Anti-Slip**

31 x 31 x 2,4

Alma  
Iconic  
Mistery  
Mythos  
Pietro  
Serena  
Stela  
Trésor



**030 Anti-Slip**

31 x 4 x 4

Iconic  
Mistery  
Mythos  
Pietro  
Serena  
Trésor

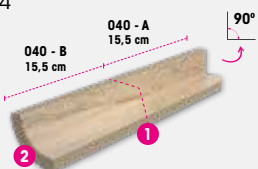

**040 Anti-Slip**

31 x 4 x 4

Iconic  
Mistery  
Mythos  
Pietro  
Serena  
Trésor



1

Radio igual a DL1 en el centro  
Radius matches DL1 in the centre  
Rayon égal à DL1 au centre

2

Radio: 4 cm  
Radius: 4 cm  
Rayon: 4 cm

En estas dos referencias, **030** y **040**, uno de los extremos acaba en un ángulo recto de 90° mientras que el otro acaba en una curva con un radio de 4 cm.

These two references, **030** and **040**, have a curve with a 4-cm radius on one end and a 90° angle on the other end.

Ces deux références, **030** et **040**, se terminent à l'une des extrémités par un angle droit de 90°, et à l'autre extrémité par une courbure d'un rayon de 4 cm.

Para esquinas interiores  
For inner corners  
Pour angles intérieurs

Para esquinas exteriores  
For outer corners  
Pour angles extérieurs

# food and floor the kit chen



**indu  
gres**

**100%  
Biostop**

## La solución más limpia para la cocina industrial

**Indugres 100% acabado biostop elimina las bacterias y garantiza la autoprotección de toda la superficie de gres porcelánico más la junta de colocación**

### Funciona 24 h en interiores y exteriores

Funciona con luz artificial, con luz natural y en completa oscuridad.

### Autoprotección total y permanente

La acción auto protectora es permanente y 100% segura. No necesita ningún tratamiento posterior ni mantenimiento para funcionar.

### Eficacia probada contra las bacterias

Evita al 100% la proliferación de bacterias como: **Staphylococcus Aureus, Escherichia Coli, Proteus Vulgaris, Salmonella typhi, Enterococcus Faecalis, Streptococcus Pyogenes, Bacillus o Listeria Monocytogenes**

### Es gres porcelánico industrial Rosa gres de alta calidad

Su proceso de fabricación garantiza que todas las propiedades del gres porcelánico industrial Rosa Gres se mantienen intactas.

### No es tóxico para la salud

Es totalmente inocuo para la salud humana.

### Reduce los olores

Evita los malos olores que pueda provocar los depósitos de microorganismos en las superficies.

## The cleanest solution for commercial kitchens

**Indugres 100% Biostop eliminates bacteria and guarantees self-protection of the entire porcelain stoneware surface including the grout joint.**

### Works 24 hours indoors and outdoors.

Works in artificial light, natural light and total darkness.

### Total and permanent self-protection.

Self-protection is permanent and 100% safe. It does not require any treatment or maintenance.

### Proven efficacy against bacteria.

Prevents 100% of bacteria growth such as: **Staphylococcus Aureus, Escherichia Coli, Proteus Vulgaris, Salmonella Typhi, Enterococcus Faecalis, Streptococcus Pyogenes, Bacillus and Listeria Monocytogenes.**

**Rosa Gres high-quality industrial porcelain stoneware.** The manufacturing process guarantees that all the properties of Rosa Gres industrial porcelain stoneware are maintained.

### Not toxic to health.

Completely harmless to human health.

### Reduces odors.

Prevents unpleasant odors caused by the accumulation of microorganisms on surfaces.

## La solution la plus propre pour les cuisines industrielles

**La finition 100% biostop d'Indugres élimine les bactéries et garantit l'autoprotection de toute la surface du grès cérame ainsi que du joint entre les carreaux**

### Fonctionne 24 heures à l'intérieur et à l'extérieur

Il Fonctionne à la lumière artificielle, à la lumière naturelle et dans l'obscurité totale.

### Auto-protection totale et permanente

L'action auto-protectrice est permanente et sûre à 100%. Aucun post-traitement ou entretien n'est nécessaire pour fonctionner.

### Efficacité prouvée contre les bactéries

Évite à 100% la prolifération de bactéries telles que : **Staphylococcus aureus, Escherichia coli, Proteus Vulgaris, Salmonella Typhi, Enterococcus faecalis, Streptococcus pyogenes, Bacillus, Listeria monocytogenes**

### Grès cérame porcelaine industriel de haute qualité

Son processus de fabrication garantit que toutes les propriétés du grès cérame industriel Rosa Gres restent intactes.

### Non toxique pour la santé

Totalement inoffensif pour la santé.

### Réduit les odeurs

Évite les odeurs désagréables causées par les dépôts de microorganismes sur les surfaces.



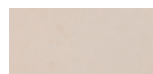

**122 G3**  
11,9 x 24,4 x 1  
Indubeige R9



**240 G3**  
24,4 x 24,4 x 1  
Indubeige R10

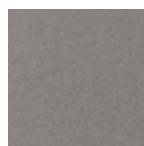

**240 G3**  
24,4 x 24,4 x 1  
Indugrey R10

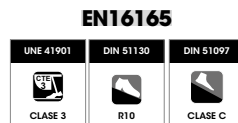

**240 G3**  
24,4 x 24,4 x 1  
Indubeige R12

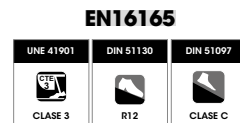

**240 G3**  
24,4 x 24,4 x 1  
Indugrey R12

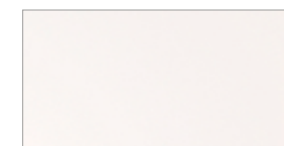
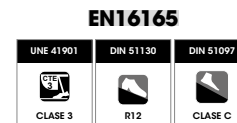

**244 G1**  
24,4 x 49,4 x 0,8  
Bio White Liso



**Bio-Cerpoxi Blanco**  
21 KG/U

**Bio-Cerpoxi Gris**  
21 KG/U

**Junta de colocación**  
**100% Biostop**

Mortero coloreado epoxi con resistencia al ataque de los ácidos y propiedades protectoras: previene el crecimiento de microorganismos perjudiciales para la salud.

**Grout Joints**  
**100% Biostop**

Coloured epoxy resin resistant to acid and with protective properties: prevents the growth of harmful microorganisms.

**Mortier de Jointoiment**  
**100% Biostop**

Mortier coloré époxy résistant aux agressions acides et présentant des propriétés protectrices pour empêcher le développement de microorganismes nocifs pour la santé.



**Medias cañas | Half round pieces | Demi-Cannes**

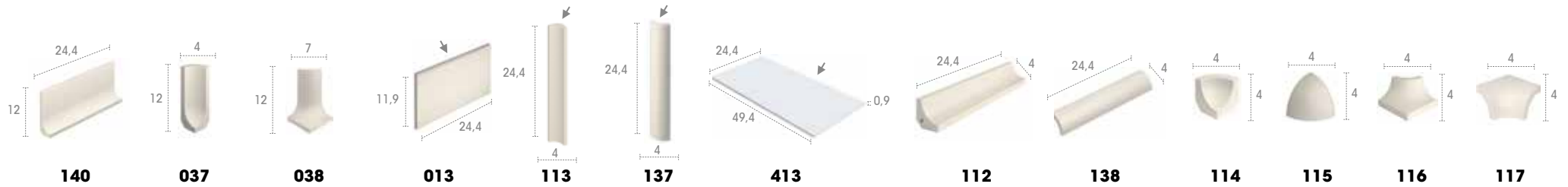
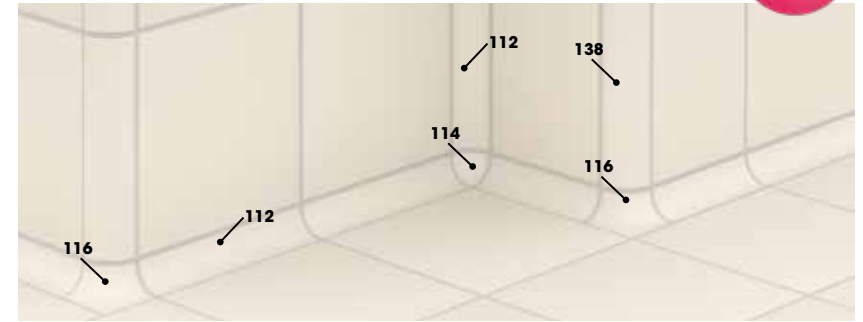
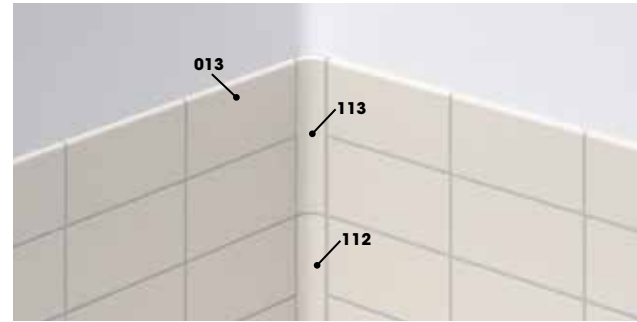
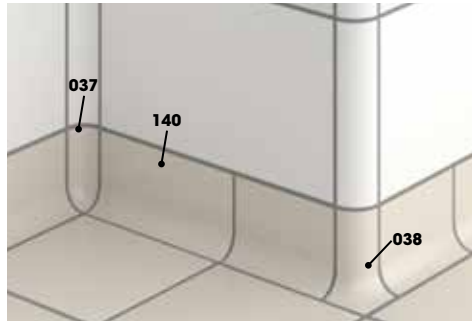

**Canaletas | Shallow Chanel | Goulottes**

**Ducha | Shower | Douche**

**Peldaños | Steps | Margelles**

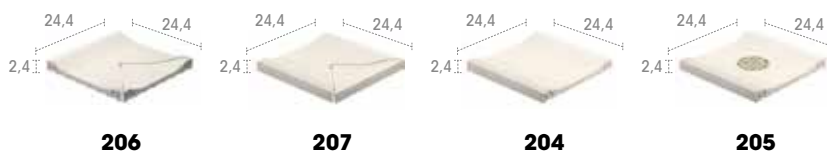
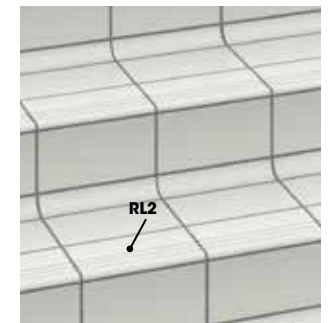
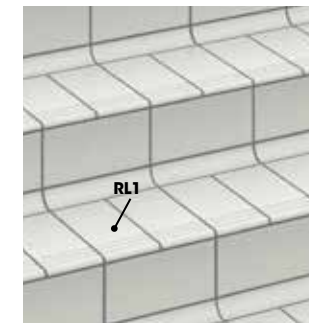
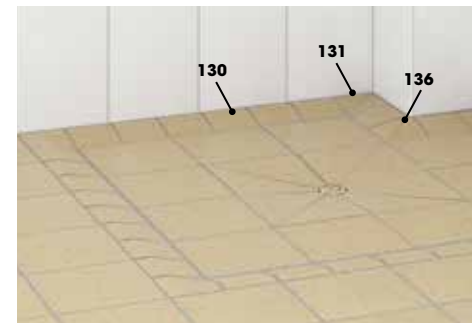
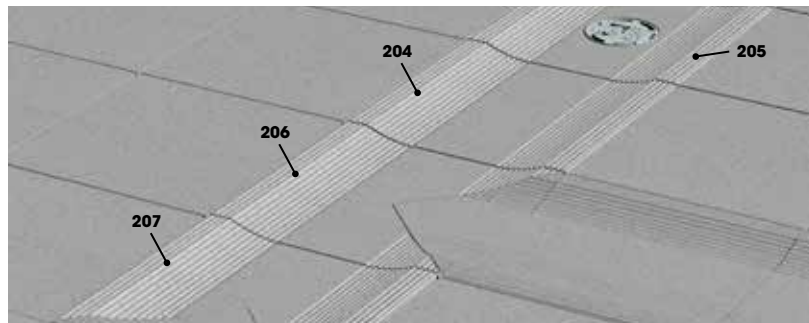

# we are eco frien dly



VER VÍDEO



WATCH VIDEO



VOIR LA VIDÉO



## NUEVA CUBIERTA SOLAR

Instalación fotovoltaica para  
el autoconsumo eléctrico

## NEW SOLAR ROOF

Photovoltaic system for  
self-consumption of electricity

## NOUVEAU TOIT SOLAIRE

Installation photovoltaïque pour  
autoconsommation électrique



**9.435 m<sup>2</sup>**  
**2.000 Kwp**  
**2.721.099 kwh** | AÑO  
YEAR  
ANNÉE





## PROYECTO ZERO NUESTRO COMPROMISO CON EL MEDIO AMBIENTE

El compromiso de **Rosa Gres** por generar el mínimo impacto medioambiental nos llevó a crear un protocolo de Sostenibilidad propio. Es nuestro **Proyecto ZERO** y se basa en los siguientes propósitos:

- Practicar una mejora continuada, de forma transversal en toda la empresa, conscientes del futuro a corto y largo plazo.
- Producir de forma eficiente y controlada para reducir el consumo de recursos naturales.
- No generar residuos durante el proceso de producción: separar, reutilizar, valorizar.
- Prever y controlar el impacto medioambiental del producto **Rosa Gres** una vez acabado: su traslado desde la fábrica, su vida útil y su reciclaje final.

### PROGRAMAS PROYECTO ZERO

#### Zero Vertidos

Reutilizamos el 100% del agua del proceso productivo.

#### Zero Residuos

Segregamos y reciclamos el 100% de los residuos valorizables.

#### Reciclaje Non-Stop

Procesamos todos los materiales del ciclo de producción para su reutilización.

#### Zero Emisiones

- Toda la potencia eléctrica que consume Rosa Gres es de origen renovable. Además se han instalado placas fotovoltaicas en la cubierta de la planta, que generan 2 MW para autoconsumo.
- Optimización mediante el control y gestión on-line de los recursos energéticos.

#### Construcción industrializada. Ecodiseño

Diseñamos sistemas constructivos que minimizan el residuo en la obra, reducen el tiempo de ejecución y aseguran el resultado final.

### CERTIFICACIONES MEDIOAMBIENTALES

**Rosa Gres** formó parte del comité de desarrollo de la normativa **DAPc®**, la nueva Ecoetiqueta europea de tipo III que permite evaluar el impacto ambiental a lo largo del ciclo de vida del producto y su proceso de fabricación.

La utilización de productos cerámicos, sistemas de construcción y sistemas de colocación **Rosa Gres** aporta puntos para los certificadores LEED, Verde, Breeam y otros.

**Rosa Gres** es miembro del **GBCe** desde junio de 2010.

## PROJECT ZERO OUR COMMITMENT TO THE ENVIRONMENT

**Rosa Gres'** commitment to minimizing our environmental impact has led us to create our own sustainability protocol, known as **Project ZERO**, which is based on the following objectives:

- Ensure continuous improvement throughout the company, taking into account short and long-term plans.
- Manufacture in an efficient and controlled manner to reduce the consumption of natural resources.
- Avoid waste in the production process by separating, reusing and recycling.
- Anticipate and control the environmental impact of the **Rosa Gres** product once it is finished, including its transfer from the factory, its life span and its final recycling.

### PROJECT ZERO PROGRAMS

#### Zero Water Discharge

We recycle 100% of the water used in the production process.

#### Zero Waste

We separate and recycle 100% of the recyclable waste.

#### Non-Stop Recycling

We recycle all materials in the production cycle.

#### Zero Emissions

- All the electricity used by Rosa Gres comes from renewable sources. In addition, photovoltaic panels have been installed on the roof of the plant, generating 2 MW of self-consumption.
- Optimization through online control and management of energy resources.

#### Industrialized construction. Ecodesign

We design construction systems that minimize waste during the construction process, reduce execution time and guarantee the final result.

### ENVIRONMENTAL CERTIFICATIONS

**Rosa Gres** was part of the development committee of the **DAPc®** standard, the new European Type III eco-label, which allows us to evaluate environmental impact throughout the life cycle of the product and the manufacturing process.

The use of **Rosa Gres** porcelain stoneware products, construction systems and installation systems can earn points for LEED, Verde, Breeam and other certifiers.

**Rosa Gres** has been a member of the **GBCe** since June 2010.

## PROJET ZÉRO NOTRE ENGAGEMENT POUR L'ENVIRONNEMENT

L'engagement de **Rosa Gres** à générer un impact minimum sur l'environnement nous a conduits à créer notre propre protocole de durabilité. Il s'agit de notre **Projet ZERO** qui se base sur les objectifs suivants :

- Assurer une amélioration continue, de manière transversale, au sein de toute l'entreprise, en étant conscients du futur à court et à long terme.
- Produire de manière efficace et contrôlée afin de réduire la consommation de ressources naturelles.
- Ne pas générer de déchets au cours du processus de production : séparer, réutiliser, valoriser.
- Anticiper et contrôler l'impact environnemental du produit **Rosa Gres** une fois terminé : son transfert depuis l'usine, sa durée de vie et son recyclage en fin de vie.

### PROGRAMMES PROJET ZÉRO

#### Zéro Eau Déversée

Nous recyclons 100% de l'eau utilisée pendant la production.

#### Zéro Déchet

Nous séparons et recyclons 100% des déchets récupérables.

#### Recyclage Non-Stop

Nous utilisons tous les matériels du cycle de production en vue de les réutiliser.

#### Zéro Émission

- Toute l'énergie électrique consommée par Rosa Gres provient de sources renouvelables. De plus, des panneaux photovoltaïques ont été installés sur le toit de l'usine, produisant 2 MW pour l'autoconsommation.

- Optimisation grâce au contrôle et à la gestion en ligne des ressources énergétiques.

#### Construction industrialisée. Écoconception

Nous concevons des systèmes de construction qui minimisent les déchets sur le chantier, réduisent le temps d'exécution et garantissent le résultat final.

### CERTIFICATIONS ENVIRONNEMENTALES

**Rosa Gres** a fait partie du comité de développement de la norme **DAPc®**, le nouveau label écologique européen de type III qui permet d'évaluer l'impact environnemental tout au long du cycle de vie du produit et de son processus de fabrication.

L'utilisation des produits céramiques, des systèmes de construction et d'installation de **Rosa Gres** permet d'obtenir des points pour les certifications LEED, Verde, Breeam et autres.

**Rosa Gres** est membre du **GBCe** depuis juin 2010.

## Projects



LUXURY				HOTEL SPA	URBAN
	Golden Crown Nazareth Hotel, Vladislavova, Israel	Elba Royal Village Resort, Lanzarote, Canary Islands, Spain		Sandos Playacar, Playa del Carmen, México	
Gran Hotel Miramar, Málaga, Spain	Amman Marriot Hotel, Amman, Jordan	Princess Inspire, Tenerife, Canary Islands, Spain.		Royal Uno Resort & Spa, Cancún, México	Aqua Hotel Silhouette & Spa, Malgrat de Mar, Barcelona, Spain
Meliá Sierra Nevada, Granada, Spain	Intercontinental Amman, Amman, Jordan	Pine Cliffs Resort Algarve, Albufeira, Portugal		Secrets Playa Mujeres Golf & Spa Resort, Cancún, México	Spa Hotel Attica 21, Vigo, Spain
Hotel Kimpton Aysla, Palma de Mallorca, Balearic Islands, Spain	The Ritz-Carlton, Montreal, Canada	Hotel Sheraton Cascais Resort, Cascais, Portugal		Dreams Playa Mujeres Golf & Spa Resort, Quintana Roo, México	Le Petit Beaumarchais, París, France
Ibiza Bay, Ibiza, Balearic Islands, Spain	Iberostar Grand Hotel Packard, La Habana, Cuba	JW Marriot Venice Resort & Spa, Venice, Italy		Meliá Paradisus los Cayos, Cayo Santa Maria, Cuba	Spa Naantali, Naantali, Finland
Hotel Royal Marine suits Lanzarote, Canary Islands, Spain	Hotel Radisson Royal, Panama City, Panama	Odyssee Resort Thalasso and Spa Oriental, Zarzis, Tunisia		Paradisus Varadero Resort & Spa, Varadero, Cuba	Hotel Europa Fit, Hévíz, Hungary
Lango Design Hotel & Spa, Kos, Greece	Hyatt Centric, Guatemala City, Guatemala	Tui Blue Oceana Suites, Hammamet, Tunisia		Valentín Varadero El Patriarca, Varadero, Cuba	Hotel Horal Wellness & Spa Hotel, Radhoštská, Czech Republic
Theros All Suit Hotel, Kos, Greece	El Cielo Hotel, Medellín, Colombia	TMK Hotel Flora Park Hammamet, Tunisia		Hotel Memories Miramar Habana, La Habana, Cuba	Spa Hotel Svoboda, Mariánské Lázně, Czech Republic
Galgorm Resort and Spa, Galgorm, United Kingdom	The Fives Ocean Front Puerto Morelos, Puerto Morelos, México	Hilton Rijeka Costabella, Beach Resort & Spa, Rijeka, Croatia		Iberostar Playa Pilar, Cayo Guillermo, Cuba	Hotel Mara Sinaia, Sinaia, Romania
Residence Inn by Marriott, Amsterdam, The Netherlands	<b>THEME HOTEL</b>	Kanika Hotels & Resorts, Limassol, Cyprus		<b>RURAL</b>	RINA Hotel, Sinaia, Romania
The Marmorosch, Bucharest, Romania	The WB Abu Dhabi, Curio Collection by Hilton, Abu Dhabi, EAU	Amavi Hotel, Paphos, Cyprus		Casa Rural Boutique Palacio Condes de Cirac, La Rioja, Spain	Hotel Horizont Resort, Stará Lesná, Slovakia
Kharkiv Palace Hotel, Kyiv, Ukraine	Costa Caribe Aquatic Park - Port Aventura, Tarragona, Spain	Hotel Meliá Durres, Gjiri, Albania		Parador Nacional Costa da Morte, Muxía, A Coruña, Spain	Hotel Impozant Valcianska Dolina, Valča, Slovakia
Spa Hotel Villa Ivanovi Dvori, Bićine, Croatia	<b>RESORT</b>	Orea Resort Santon, Brno-Bystrc, Czech Republic.		Hotel Pazo O Rial, Villagarcía de Arousa, Pontevedra, Spain	Hotel Termal Vyhne, Vyhne, Slovakia
Hilton Malta Hotel, St Julian's, Malt	Barceló Costa Ballena Golf & Spa, Cádiz, Spain	Complex Hotelier Steaua de Mare, Eforie Nord, Romania		Panoráma Hotel, Štrba, Slovakia	Terme Olimia D.D., Podčetrtek, Slovenia
Six Senses Kaplankaya, Bodrum, Turkey	Barceló Montecastillo Golf, Jerez de la Frontera, Spain	Royalton Grenada, Saint George, Grenada		Hotel Rozsutek, Terchová, Slovakia	SPA Orkana, Lublin, Poland
Hotel Sun Bat Yam, Bat Yam, Israel	Barceló Punta Umbría Beach Resort, Punta Umbría, Spain	Mamula Island Hotel, Mamula Island, Montenegro		Resort Sobotín, Sobotín, Czech Republic	Uvildy Resort, Karabash, Russia
The Jaffa, Luxury Collection Tel Aviv, Israel	St. Regis Mardavall Mallorca Resort, Palma de Mallorca, Balearic Islands, Spain	Lopesan Costa Bávaro Resort, Spa & Casino, Punta Cana, Dominican Republic		Hotel Grand Kopaonik, Kopaonik, Serbia	
					<b>CAMPING</b>
					Camping & Resort Sangulí, Salou, Tarragona, Spain
					Camping La Plage, Argelès-sur-Mer, France

NORMA DE ENSAYO / TESTING STANDARD / NORME D'ESSAI			REGULACIÓN / REGULATION / RÉGLEMENTATION EN 14411 - ISO 13006		Rosa Gres
	ISO 10545 - 2	Características dimensionales Dimensions and surface quality Dimensions et aspect de la surface	Exigida Required Exigée		Garantizada Guaranteed Garantie
	ISO 10545 - 3	Absorción de agua Water absorption Absorption d'eau	Grupo B1a Grupo A1a E ≤ 0,5 %		E ≤ 0,5 %
	ISO 10545 - 4	Fuerza de rotura Breaking strength Effort à la rupture	≥ 1.300 N		≥ 1.300 N
		Resistencia a la flexión Modulus of rupture Résistance à la flexion	≥ 35 N/mm <sup>2</sup>		≥ 35 N/mm <sup>2</sup>
	ISO 10545 - 9	Resistencia al choque térmico Thermal shock resistance Résistance aux chocs thermiques	Exigida Required Exigée		Garantizada Guaranteed Garantie
	ISO 10545 - 12	Resistencia a la helada Frost resistance Résistance au gel	Exigida Required Exigée		Garantizada Guaranteed Garantie
	ISO 10545 - 13	Resistencia química <sup>(1)</sup> Chemical resistance <sup>(1)</sup> Résistance chimique <sup>(1)</sup>	Min. Clase B		A LA HA
	ISO 10545 - 14	Resistencia a las manchas Stain resistance Résistance aux tâches	Min. Clase 3		Garantizada Guaranteed Garantie

<sup>(1)</sup> Excepto ácido fluorhídrico y sus compuestos | Except hydrofluoric acid and its components | A l'exception de l'acide fluorhydrique et ses composés  
Piezas base: grupo B1a | Field tiles: grupo B1a | Pièces de base: grupo B1a  
Piezas especiales: grupo A1a | Trim pieces: grupo A1a | Pièces spéciales: grupo A1a

## SEGURIDAD / SAFETY / SÉCURITÉ

COEFICIENTES DE ANTIDESLIZAMIENTO / NON-SLIP COEFFICIENTS / COEFFICIENTS DE RÉSISTANCE			LISO / SMOOTH FINISH / FINITIONS LISSES		ANTIDESLIZANTE / ANTI-SLIP FINISH / FINITIONS ANTIDÉRAPANTE	
	EN 16165 Anexo A (DIN 51097)	Norma para pie desnudo Norm for barefoot traffic areas Norme pour pieds nus	-		Clase C ≥ 24°	Alma - Iconic - Mistery - Mythos Pietro - Serena - Stela - Trésor
	EN 16165 Anexo B (DIN 51130)	Norma para pie calzado Norm for footwear traffic areas Norme pour pieds chaussés	R9 ≥ 6° - <10°	Alma - Iconic Mistery - Mythos Stela	R10 > 10° - 19°	Trésor
					R11 > 19° - 27°	Alma - Iconic - Mistery - Mythos Pietro - Serena - Stela
	EN 16165 Anexo C (UNE 41901)	Pendulum Test	Clase 1 15 < Rd ≤ 35	Alma - Iconic Mistery - Stela Mythos	Clase 3 Rd > 45	Alma - Iconic - Mistery - Mythos Pietro - Serena - Stela - Trésor
ANSI A326.3		Coefficiente de fricción Coefficient of friction Coefficient de friction	-		Exterior wet ≥ 0,55	Alma - Iconic - Mistery - Mythos Pietro - Serena - Stela - Trésor



Portada y contraportada | Cover and back cover | Couverture et quatrième de couverture: **Kimpton Aysla Mallorca. IHG, Hotels & Resorts. Santa Ponsa, Calvià, Mallorca, Balearic Islands, Spain**



#### **Rosa Gres, SLU**

**Oficina Central - Central office - Bureau Central**

Ctra. Sant Cugat, km. 3

08290 Cerdanyola, Barcelona, Spain

Tel. + 34 93 586 30 60

Ventas: + 34 93 586 37 00

Export Sales: + 34 93 586 37 02

info@rosagres.com

www.rosagres.com

#### **Rosa Gres France, SARL**

64140 Lons, France

Tel. + 00 33 411 92 00 30

contact@rosagres.com

administration@rosagres.com

www.rosagres.com/fr

#### **Fábrica - Factory - Fabrique**

Pol. Ind. Mas Vell

Ramón Sugrañes, 1

43144 Vallmoll, Tarragona, Spain

