

CENTURA



Journey

4 COLOURS

4 SIZES

3 SURFACES

Interpreted as a journey through the landscapes of Northern Europe, Journey is the synthesis of all those characteristics that allow to define welcoming and natural areas able to express, through colors, surfaces, sizes and decorations, the contemporary taste of the world of interior design.

CERAMICHE PIEMME
FLOOR AND MORE

Informazioni Tecniche

4

Colori
Colours
Farben
Couleurs

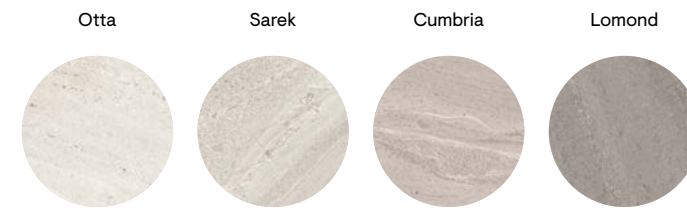

4

Formati
Sizes
Formate
Formats

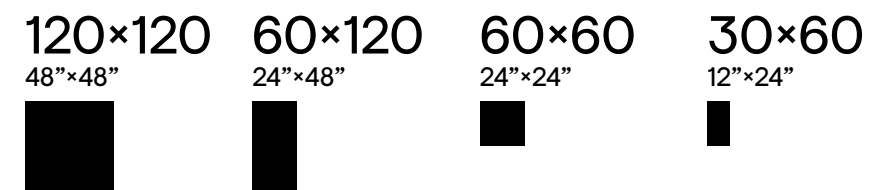

2

Spessori
Thickness
Stärke
Epaisseur

±9

±9,5

3

Superfici
Surfaces
Oberflächen
Surfaces

Naturale

Silk

Antislip

4

Strutture 3D
3D structures
Strukturen
Décorations en relief

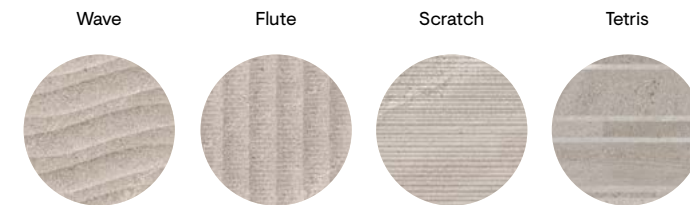

i



Tecnologia - Technology - Technologie:
Synchro Digit Piemme™
Superficie con struttura digitale sincronizzata
Synchronized digital structured surface
Im synchronisierten Digitaldruckverfahren
hergestellte 3D-Oberfläche
Surface avec texture et finition par
impression numérique synchronisée

Gres fine porcellanato ad impasto colorato
Coloured-body fine porcelain stoneware
Feinsteinzeug aus farbiger Masse
Grès cérame fin à pâte colorée

Effetto Pietra
Stone Look
Natursteinoptik
Effet Pierre

Rivestimento
Wall Tiles
Wandfliesen
Revêtement

Pavimento
Floor Tiles
Bodenfliesen
Sol



Gres fine porcellanato ad impasto colorato
Tecnologia Digitale

Coloured-body fine porcelain stoneware
Digital Technology

Feinsteinzeug aus farbiger Masse
Digital Technologie

Grès cérame fin à pâte colorée
Technologie Numérique

Otta

Per un risultato di posa ottimale si consiglia di prelevare le piastrelle da 5/6 scatole contemporaneamente.

For best installation results, we suggest taking the tiles from 5/6 boxes at the same time.



± 9

120×120 - 48"×48"

04953 | Journey Otta Nat/Ret
05299 | Journey Otta Silk/Ret



± 9,5

60×60 - 24"×24"

04717 | Journey Otta Nat/Ret
04722 | Journey Otta Silk/Ret



± 9,5

30×60 - 12"×24"

04726 | Journey Otta Nat/Ret
04731 | Journey Otta Silk/Ret



± 9,5

60×120 - 24"×48"

04671 | Journey Otta Nat/Ret
04678 | Journey Otta Silk/Ret



60×120 - 24"×48"

04688 | Journey Scratch Otta Nat/Ret
(Synchro Digit Piemme Technology)



30×60 - 12"×24"

04735 | Journey Wave Otta Nat/Ret



± 9,5

60×120 - 24"×48"

***04697** | Journey Otta Antislip/Ret
(Synchro Digit Piemme Technology)



60×120 - 24"×48"

04687 | Journey Tetris Warm Nat/Ret
(Synchro Digit Piemme Technology)



30×60 - 12"×24"

04739 | Journey Flute Otta Nat/Ret

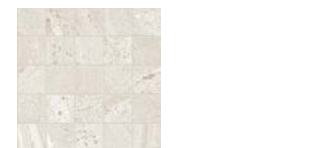

30×30 - 12"×12"

04937 | Journey Mosaico Otta Nat/Ret

*L'articolo non ha verso di posa
Item with no laying direction
Artikel ohne Verlegerichtung
Article sans sens de pose

Pezzi speciali
Special pieces

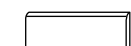

Battiscopa 4,5×60 ± 9,5

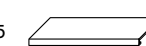

Gradino Costa Retta 33×120 ± 9,5



Gres fine porcellanato ad impasto colorato
Tecnologia Digitale

Coloured-body fine porcelain stoneware
Digital Technology

Feinsteinzeug aus farbiger Masse
Digital Technologie

Grès cérame fin à pâte colorée
Technologie Numérique

Sarek

Per un risultato di posa ottimale si consiglia di prelevare le piastrelle da 5/6 scatole contemporaneamente.

For best installation results, we suggest taking the tiles from 5/6 boxes at the same time.



± 9

120×120 - 48"×48"

04954 | Journey Sarek Nat/Ret
05301 | Journey Sarek Silk/Ret



± 9,5

60×60 - 24"×24"

04718 | Journey Sarek Nat/Ret
04723 | Journey Sarek Silk/Ret

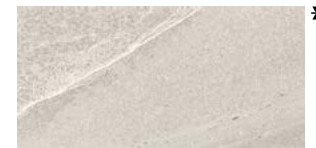

± 9,5

30×60 - 12"×24"

04727 | Journey Sarek Nat/Ret
04732 | Journey Sarek Silk/Ret



± 9,5

60×120 - 24"×48"

04673 | Journey Sarek Nat/Ret
04681 | Journey Sarek Silk/Ret



60×120 - 24"×48"

04689 | Journey Scratch Sarek Nat/Ret
(Synchro Digit Piemme Technology)



30×60 - 12"×24"

04736 | Journey Wave Sarek Nat/Ret



± 9,5

60×120 - 24"×48"

***04699** | Journey Sarek Antislip/Ret
(Synchro Digit Piemme Technology)



60×120 - 24"×48"

04687 | Journey Tetris Warm Nat/Ret
(Synchro Digit Piemme Technology)



30×60 - 12"×24"

04741 | Journey Flute Sarek Nat/Ret

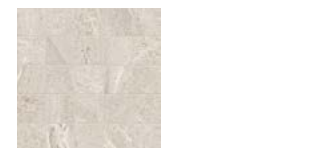

30×30 - 12"×12"

04938 | Journey Mosaico Sarek Nat/Ret

*L'articolo non ha verso di posa
Item with no laying direction
Artikel ohne Verlegerichtung
Article sans sens de pose

Pezzi speciali
Special pieces

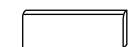

Battiscopa 4,5×60 ± 9,5

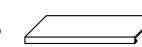

Gradino Costa Retta 33×120 ± 9,5



Cumbria

Per un risultato di posa ottimale si consiglia di prelevare le piastrelle da 5/6 scatole contemporaneamente.

For best installation results, we suggest taking the tiles from 5/6 boxes at the same time.



± 9

120x120 - 48"x48"

04955 | Journey Cumbria Nat/Ret
05302 | Journey Cumbria Silk/Ret



± 9,5

60x60 - 24"x24"

04719 | Journey Cumbria Nat/Ret
04724 | Journey Cumbria Silk/Ret



± 9,5

30x60 - 12"x24"

04728 | Journey Cumbria Nat/Ret
04733 | Journey Cumbria Silk/Ret



± 9,5

60x120 - 24"x48"

04674 | Journey Cumbria Nat/Ret
04682 | Journey Cumbria Silk/Ret



60x120 - 24"x48"

04691 | Journey Scratch Cumbria Nat/Ret
(Synchro Digit Piemme Technology)



30x60 - 12"x24"

04737 | Journey Wave Cumbria Nat/Ret



± 9,5

60x120 - 24"x48"

***04701** | Journey Cumbria Antislip/Ret
(Synchro Digit Piemme Technology)



60x120 - 24"x48"

04685 | Journey Tetris Cold Nat/Ret
(Synchro Digit Piemme Technology)



30x60 - 12"x24"

04742 | Journey Flute Cumbria Nat/Ret



30x30 - 12"x12"

04939 | Journey Mosaico Cumbria Nat/Ret

*L'articolo non ha verso di posa
Item with no laying direction
Artikel ohne Verlegerichtung
Article sans sens de pose

Pezzi speciali
Special pieces

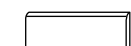

Battiscopa 4,5x60 ± 9,5

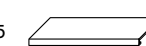

Gradino Costa Retta 33x120 ± 9,5



Gres fine porcellanato ad impasto colorato
Tecnologia Digitale

Coloured-body fine porcelain stoneware
Digital Technology

Feinsteinzeug aus farbiger Masse
Digital Technologie

Grès cérame fin à pâte colorée
Technologie Numérique

Lomond

Per un risultato di posa ottimale si consiglia di prelevare le piastrelle da 5/6 scatole contemporaneamente.

For best installation results, we suggest taking the tiles from 5/6 boxes at the same time.



± 9

120x120 - 48"x48"

04956 | Journey Lomond Nat/Ret
05303 | Journey Lomond Silk/Ret



± 9,5

60x60 - 24"x24"

04721 | Journey Lomond Nat/Ret
04725 | Journey Lomond Silk/Ret



± 9,5

30x60 - 12"x24"

04729 | Journey Lomond Nat/Ret
04734 | Journey Lomond Silk/Ret



± 9,5

60x120 - 24"x48"

04676 | Journey Lomond Nat/Ret
04683 | Journey Lomond Silk/Ret



60x120 - 24"x48"

04693 | Journey Scratch Lomond Nat/Ret
(Synchro Digit Piemme Technology)



30x60 - 12"x24"

04738 | Journey Wave Lomond Nat/Ret



± 9,5

60x120 - 24"x48"

***04705** | Journey Lomond Antislip/Ret
(Synchro Digit Piemme Technology)



60x120 - 24"x48"

04685 | Journey Tetris Cold Nat/Ret
(Synchro Digit Piemme Technology)



30x60 - 12"x24"

04743 | Journey Flute Lomond Nat/Ret



30x30 - 12"x12"

04940 | Journey Mosaico Lomond Nat/Ret

* L'articolo non ha verso di posa
Item with no laying direction
Artikel ohne Verlegerichtung
Article sans sens de pose

Pezzi speciali
Special pieces

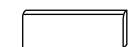



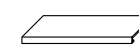

Battiscopa 4,5x60 ± 9,5



Gradino Costa Retta 33x120 ± 9,5







Riepilogo Gamma

Collection
Serie
Gamme

	Formati Sizes	120x120 48"x48"				60x120 24"x48"				60x60 24"x24"		30x60 12"x24"		Strutture 3D 3D Structures					Pezzi Speciali Special Pieces	
		120x120 48"x48"	60x120 24"x48"	60x60 24"x24"	30x60 12"x24"	DIN 51130	DIN 51097	DCOF	BS EN 7976-2	AS 4586 2013	Tetris 60x120 24"x48"	Scratch 60x120 24"x48"	Wave 30x60 12"x24"	Flute 30x60 12"x24"	Mosaico 30x30 12"x12"	Gradino Costa Retta 33x120 13"x48"	Battiscopa 4,5x60 1½"x24"			
		± 9	± 9,5	± 9,5	± 9,5										± 9,5	± 9,5	± 9,5	± 9,5	± 9,5	± 9,5
 Otta	Nat/Ret	04953	04671	04717	04726	R10	B	>0.42	wet, dry >36	P3	04687	04688	04735	04739	04937	04941	04929			
	Silk/Ret	05299	04678	04722	04731	V2		>0.42								04945	04933			
	Antislip/Ret		04697			R11	A+B+C	>0.42	wet, dry >36	P4										
 Sarek	Nat/Ret	04954	04673	04718	04727	R10	B	>0.42	wet, dry >36	P3	04687	04689	04736	04741	04938	04942	04930			
	Silk/Ret	05301	04681	04723	04732	V2		>0.42								04946	04934			
	Antislip/Ret		04699			R11	A+B+C	>0.42	wet, dry >36	P4										
 Cumbria	Nat/Ret	04955	04674	04719	04728	R10	B	>0.42	wet, dry >36	P3	04685	04691	04737	04742	04939	04943	04931			
	Silk/Ret	05302	04682	04724	04733	V2		>0.42								04947	04935			
	Antislip/Ret		04701			R11	A+B+C	>0.42	wet, dry >36	P4										
 Lomond	Nat/Ret	04956	04676	04721	04729	R10	B	>0.42	wet, dry >36	P3	04685	04693	04738	04743	04940	04944	04932			
	Silk/Ret	05303	04683	04725	04734	V2		>0.42								04948	04936			
	Antislip/Ret		04705			R11	A+B+C	>0.42	wet, dry >36	P4										

Imballi

Packing
Verpackung
Emballage

Formati Sizes	± MM	 Pezzi Scatola Pieces/Box Stck/Karton Carreaux/Boîte	 Mq/Scatola Sqmt/Box Qm/Karton M2/Boîte	 Kg/Scatola Kgs/Box Kg/Karton Kg/Boîte	 Scatole/Paletta Boxes/Pallet Karton/Palette Boîte/Palette	 Mq/Paletta Sqmt/Pallet Qm/Pallet M2/Palette	 Kg/Paletta Kgs/Pallet Kg/Pallet Kg/Palette	 Formato Paletta Size Pallet Format Pallet Dim. Palette	
120x120 (48"x48") Nat/Ret - Silk/Ret	P	9	2	2,880	58,00	22	63,36	1276,00	143x126x67
60x120 (24"x48") Nat/Ret - Silk/Ret - Antislip/Ret	P	9,5	2	1,440	31,00	30	43,20	930,00	122x80x96
60x60 (24"x24") Nat/Ret - Silk/Ret	P	9,5	4	1,440	29,00	32	46,08	928,00	120x80x75
30x60 (12"x24") Nat/Ret - Silk/Ret	P	9,5	7	1,260	25,30	40	50,40	1012,00	120x80x75
60x120 (24"x48") Tetris Nat/Ret	P	9,5	2	1,440	31,00	30	43,20	930,00	122x80x96
60x120 (24"x48") Scratch Nat/Ret	P	9,5	2	1,440	31,00	30	43,20	930,00	122x80x96
30x60 (12"x24") Wave Nat/Ret	P	9,5	7	1,260	26,30	32	40,32	841,60	120x80x75
30x60 (12"x24") Flute Nat/Ret	P	9,5	7	1,260	26,30	32	40,32	841,60	120x80x75
30x30 (12"x12") Mosaico Nat/Ret	P	9,5	5	0,45	8,50	60	-	-	-
Pezzi Speciali / Special Pieces									
33x120 (13"x48") Gradino Costa Retta Nat/Ret - Silk/Ret	P	9,5	2	0,792	18,50	20	-	-	-
4,5x60 (1½"x24") Battiscopa Nat/Ret - Silk/Ret	P	9,5	14	0,378	8,00	80	-	-	-

Pezzi Speciali

Special pieces
Formstücke
Pièces spéciales

Battiscopa Nat/Ret 4,5×60 – 1¼”×24” ± 9,5
Battiscopa Silk/Ret 4,5×60 – 1¼”×24” ± 9,5

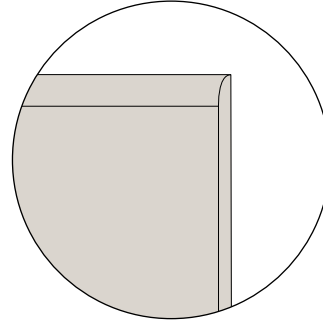
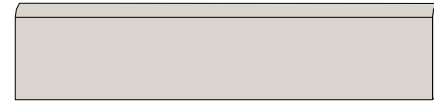

Gradino Costa Retta Nat/Ret 33×120 – 13”×48” ± 9,5
Gradino Costa Retta Silk/Ret 33×120 – 13”×48” ± 9,5
(costa retta ottenuto per taglio e incollaggio - obtained by cutting and gluing)

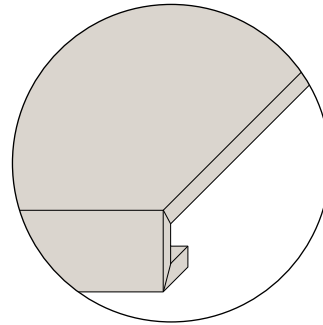

Caratteristiche Tecniche

Technical characteristics
Technische daten
Caracteristiques techniques

CLASSIFICAZIONE SECONDO NORME EN 14411 BI_A – ISO 13006 – CLASSIFICATION IN ACCORDANCE WITH EN 14411 BI_A – ISO 13006
KLASSIFIZIERUNG GEMÄSS NORMEN EN 14411 BI_A – ISO 13006 – CLASSIFICATION SELON LES NORMES EN 14411 BI_A – ISO 13006

CARATTERISTICA TECNICA TECHNICAL CHARACTERISTIC TECHNISCHE DATEN CARACTÉRISTIQUE TECHNIQUE	NORMA NORM NORM NORME	VALORE PRESCRITTO VALUE REQUIRED NORMVORGABE VALEUR PRESCRIPTE	VALORE MEDIO MEAN VALUE MITTELWERT VALEUR MOYENNE	NORMA NORM NORM NORME	VALORE MEDIO MEAN VALUE MITTELWERT VALEUR MOYENNE
LUNGHEZZA E LARGHEZZA LENGHT AND WIDTH / LÄNGE UND BREITE / LONGUEUR ET LARGEUR		±0.6% (±2.00 MM)			
SPESORE THICKNESS / STÄRKE / ÉPAISSEUR		±5% (±0.5 MM)			
RETILINEITÀ LATI WARPAGES OF EDGES / GERADHEIT DER KANTEN / RÉCITUDE DES ARÊTES	ISO 10545.2	±0.5% (±1.5 MM)	CONFORME IN ACCORDANCE ERFÜLLT CONFORME	ASTM C-499 ASTM C-485 ASTM C-502	IN ACCORDANCE
ORTOGONALITÀ WEDGING / RECHTWINKLIGKEIT / ORTHOGONALITÉ		±0.5% (±2.00 MM)			
PLANARITÀ FLATNESS / PLANITÄT / PLANIMÉTRIE		±0.5% (±2.00 MM)			
ASSORBIMENTO % D'ACQUA WATER ABSORPTION WASSERANNAHME % ABSORPTION D'EAU %	ISO 10545.3	≤ 0.5%	CONFORME IN ACCORDANCE ERFÜLLT CONFORME	ASTM C-373	IN ACCORDANCE
RESISTENZA ALLA FLESSIONE BENDING STRENGTH BIEGEZUGFESTIGKEIT RÉSISTANCE À LA FLEXION	ISO 10545.4	Modulus of rupture (average): R ≥ 35N/mm ² Breaking strength for thickness ≥ 7.5 mm S > 1300 N	CONFORME IN ACCORDANCE ERFÜLLT CONFORME	ASTM C-648 250 LBS OR GREATER	IN ACCORDANCE
DILATAZIONE TERMICA LINEARE TRA 20° E 100° C LINEAR THERMAL EXPANSION BETWEEN 20° AND 100° C LINEARE WÄRMEAUSSDEHNUNG ZWISCHEN 20° UND 100° C DILATATION THERMIQUE LINEAIRE ENTRE 20° ET 100° C	ISO 10545.8	SECONDO I DATI DEL COSTRUTTORE ACCORDING TO BUILDERS SPECIFICATIONS LAUT ANGABEN DES HERSTELLERS SELON LES ELEMENTS DU COSTRUCTEUR	≈ 7X10 ⁻⁶ C ⁻¹		
RESISTENZA AGLI SBALZI TERMICI THERMAL SHOCK RESISTANCE TEMPERATURWECHSELBESTÄNDIGKEIT RÉSISTANCE AUX ÉCARTS DE TEMPÉRATURE	ISO 10545.9	RICHIESTA REQUEST BITTE DEMANDE	RESISTENTE RESISTANT WIDERSTEHEND RÉSISTANT		
RESISTENZA AL GELO FROST RESISTANCE FROSTBESTÄNDIGKEIT RÉSISTANCE AU GEL	ISO 10545.12	RICHIESTA REQUEST BITTE DEMANDE	RESISTENTE RESISTANT WIDERSTEHEND RÉSISTANT	ASTM C-1026	IN ACCORDANCE
RESISTENZA ALL'ATTACCO CHIMICO RESISTANCE TO CHEMICAL ATTACK BESTÄNDIGKEIT GEGEN CHEMIKALIEN RÉSISTANCE À L'ATTAQUE CHIMIQUE	ISO 10545.13	SECONDO I DATI DEL COSTRUTTORE ACCORDING TO BUILDERS SPECIFICATIONS LAUT ANGABEN DES HERSTELLERS SELON LES ELEMENTS DU COSTRUCTEUR	RESISTENTE RESISTANT WIDERSTEHEND RÉSISTANT	ASTM C-650	IN ACCORDANCE
RESISTENZA DEI COLORI ALLA LUCE COLOURS RESISTANCE TO LIGHT LICHTBESTÄNDIGKEIT RÉSISTANCE DES COULEURS À LA LUMIÈRE	DIN 51094	NESSUNA ALTERAZIONE NO ALTERATION KEINE VERÄNDERUNG AUCUNE ALTERATION	CONFORME IN ACCORDANCE ERFÜLLT CONFORME		
RESISTENZA ALLE MACCHIE STAIN RESISTANCE FLECKENFESTIGKEIT RÉSISTANCE AUX TACHES	ISO 10545.14	≥ CLASSE 3 METODO DI PROVA DISPONIBILE TEST METHOD AVAILABLE VERFÜGBARE PRÜFMETHODE METHODE D'ESSAI DISPONIBILE	CONFORME IN ACCORDANCE ERFÜLLT CONFORME		
RESISTENZA ALLO SCIVOLAMENTO SLIPPAGE RESISTANCE RUTSCHSICHERHEIT RÉSISTANCE AU GLISSEMENT	DIN 51130 *	9 ≤ R ≤ 13	NAT SILK ANTISLIP	R10 ASTM C-1028 * COF ≥ 0.6 DRY ≥ 0.6 WET	NAT SILK ANTISLIP
	DIN 51097 *	A,B,C	NAT SILK ANTISLIP	B ANSI * 137.1-2012 DCOF > 0.42 WET	NAT SILK ANTISLIP
	BS EN 7976-2*	> 36 DRY > 36 WET	NAT SILK ANTISLIP	Wet, Dry > 36 AS 4586-2013 CLASS	NAT SILK ANTISLIP

*TRATTANDOSI DI NORMATIVE NAZIONALI, I METODI DI PROVA, I REQUISITI E LE CLASSIFICAZIONI VARIANO DA PAESE A PAESE. IL VALORE ATTESO DALLA RESISTENZA ALLO SCIVOLAMENTO DELLA PRODUZIONE DI INDUSTRIE CERAMICHE PIEMME S.P.A., PUÒ VARIARE IN BASE AL LOTTO PRODUTTIVO. SPECIFICA DOCUMENTAZIONE È DISPONIBILE SU RICHIESTA.
TEST METHODS, REQUIREMENTS AND CLASSIFICATIONS DIFFER FROM COUNTRY TO COUNTRY, ACCORDING TO THE NATIONAL REGULATIONS. THE EXPECTED VALUE OF SLIPPAGE RESISTANCE OF PRODUCTS BY INDUSTRIE CERAMICHE PIEMME S.P.A. MAY VARY DEPENDING ON THE PRODUCTION BATCH. SPECIFIC DOCUMENTS ARE AVAILABLE UPON REQUEST.
PRÜFVERFAHREN, ERFORDERNISSE UND KLASSIFIKATIONEN SIND VERSCHIEDEN VON LAND ZU LAND, GEMÄSS DER NATIONALEN VORSCHRIFTEN. DER ERWARTUNGSWERT DER RUTSCHSICHERHEIT DER PRODUKTE VON INDUSTRIE CERAMICHE PIEMME S.P.A. KANN SICH - JE NACH DER PRODUKTIONSPARTIE - VERÄNDERN. SPEZIFISCHE UNTERLAGEN SIND AUF VERLANGEN ZUR VERFÜGUNG.
LES MÉTHODES D'ESSAI, LES RÉQUISITIONS ET LES CLASSIFICATIONS CHANGENT DE PAYS À PAYS, SELON LES RÉGLEMENTATIONS NATIONALES. LA VALEUR ATTENDUE DE RÉSISTANCE AU GLISSEMENT DES PRODUITS DE INDUSTRIE CERAMICHE PIEMME S.P.A. PEUT VARIER EN FONCTION DU LOT DE PRODUCTION. UNE DOCUMENTATION SPÉCIFIQUE EST DISPONIBLE SUR DEMANDE.

ELENCO DELLE SERIE CERTIFICATE E CLASSIFICAZIONI DISPONIBILI A RICHIESTA - LIST OF CERTIFIED SERIES AND CLASSIFICATIONS AVAILABLE UPON REQUEST
LISTE DER GEPRÜFTEN SERIE UND KLASSIFIZIERUNGEN AUF ANFRAGE ERHÄLTLIICH - LISTE DES SERIES CERTIFIÉES ET DES CLASSEMENTS DISPONIBLES SUR DEMANDE



CERAMICHE PIEMME
FLOOR AND MORE

